

URGENT BUSINESS AND SUPPLEMENTARY INFORMATION

Executive

6 November 2017

Agenda Item Number	Page	Title	Officer Responsible	Reason Not Included with Original Agenda
9.	Pages 1 - 150	Cherwell Design Guide: Supplementary Planning Document	Design and Conservation Team Leader	Published as a supplement to the main agenda due to the size of the document

If you need any further information about the meeting please contact Natasha Clark, Democratic and Elections natasha.clark@cherwellandsouthnorthants.gov.uk, 01295 221589

This page is intentionally left blank



Cherwell Design Guide

Supplementary Planning Document

Masterplanning and architectural design guidance for residential development

October 2017

Draft

Cherwell

DISTRICT COUNCIL
NORTH OXFORDSHIRE

The Draft Cherwell Design Guide has been prepared by Cherwell District Council in collaboration with Alan Baxter Ltd and ESHA Architects.

Acknowledgements:

Cllr. Colin Clarke, CDC

Clare Mitchell, CDC

Linda Griffiths, CDC

Jon Westerman, CDC

Clare Coats, Alan Baxter Ltd

Isobel Knapp, Alan Baxter Ltd

Boris Bogdanovich, Alan Baxter Ltd

Peterjohn Smyth, ESHA Architects

Cherwell Design Guide

Supplementary Planning Document

Masterplanning and architectural design guidance for residential development

October 2017

1	THE IMPORTANCE OF HIGH QUALITY DESIGN	1
2	CHERWELL'S SPECIAL CHARACTER	9
3	RESPONDING TO THE SITE AND ITS CONTEXT	27
4	ESTABLISHING THE STRUCTURING PRINCIPLES	35
5	STREETS AND SPACES	57
6	BUILDING AND PLOT ARRANGEMENTS	83
7	BUILDING ELEVATIONS AND DETAILS	101
8	INNOVATION AND SUSTAINABILITY	119
	APPENDICES	129

FOREWORD

Cherwell is an attractive district, structured around the historic market towns of Banbury and Bicester and its attractive villages and rural hamlets. The area has a distinct character born out of its geology, landscape and history and its places are well valued by those who live here and from those who visit from further afield.

The value of good design is well understood. Well-designed places add environmental, economic, social and cultural value. The Cherwell Design Guide has been produced to ensure that new residential development results in vibrant, sustainable, safe and attractive places that add to the District's legacy. The Guide is not focused on building detail, but intends to support the development of new places that reinforce the character and vitality of a settlement. Central to this is the need for development that provides safe places to live and work, promotes sustainable transport and ways of living with good connections to local facilities.

Over the Local Plan period to 2031, Cherwell will experience unprecedented growth that will bring over 22,000 new homes and many new jobs to the District. The Cherwell Local Plan sets a vision for high quality and locally distinctive design. The ethos of the Design Guide is underpinned by a commitment from the Council to promote exemplary standards of design across the District. Our aim is to create great buildings and desirable places that are valued by future generations and add value to the development process.

Achieving this ambition is only possible through working in partnership with multiple stakeholders. In the production of this document, the Council has sought the views of councillors, planners, developers and the local community and all these parties need to be active stakeholders as new development proposals are shaped. We hope you will welcome the guidance and use it to support a positive legacy of great places and well-loved neighbourhoods.

Cllr. Colin Clarke
Lead Member for Planning
Cherwell District Council

1 THE IMPORTANCE OF HIGH QUALITY DESIGN



- 1.1 A new era for design in Cherwell
- 1.2 The role of the Design Guide
- 1.3 The design and planning process
- 1.4 Policy background
- 1.5 Abbreviations

1.1 A new era for design in Cherwell

High quality design supports a positive legacy, leaving successful places which are both functional and beautiful, which engender a sense of community, are long lasting and age well.

The District of Cherwell is known for its distinctive picturesque villages and diverse, historic market town centres. These places have a strong character rooted in the local landscape and have evolved over many centuries.

Looking to the future, the evolution of the District's settlements is set to continue at a rapid pace, with a significant number of new homes planned reflecting Cherwell's attractiveness as a place to live and work. This vision is set out in the Cherwell Local Plan 2011 – 2031 Part 1 (adopted July 2015).

Cherwell District Council is committed to protecting and enhancing the special character of the District. The Cherwell Design Guide has been written to support high quality residential development, primarily on major and strategic development sites. Guiding the development of locally distinctive places that reinforce the positive character of the district.

This is an exciting opportunity to create new places which are of a high standard and fit well with the established character of the District. Investment in high quality design today will create a legacy of delightful and successful places for future generations to enjoy. It will support the wider economic prosperity of the District by providing the right mix of high quality homes to attract and retain workers.

The Council has made a commitment to raising the standard of design across the District through Policy ESD15 of the Cherwell District Local Plan, 2015 and recognises that there are lessons to be learnt from less successful twentieth century developments.

It is intended that the Guide will:

- Support more efficient and effective decision making in the planning process
- Provide clarity and more certainty to developers on the Council's approach to design
- Promote good quality design and inspire high quality development
- Engage residents of Cherwell in the shaping of their built environment



North West Bicester

1

1.2 The role of the Design Guide

This Draft Design Guide is an important document that supports the Council’s drive to significantly raise the standard of residential design across the District. It forms part of a wider design quality initiative which will include design review, alongside member and officer training.

Following public consultation, the Design Guide will be adopted as a Supplementary Planning Document and will be a material consideration in the determination of planning applications.

The Design Guide provides further explanation and guidance in relation to Policy ESD15 of the Cherwell Local Plan 2011 – 2031 Part 1, explaining what high quality design means in practical terms and why it matters. It is a technical guide, providing clarity and certainty on the design standards that are required. In doing so, it supports a streamlined planning application process and the timely delivery of new homes.

It is designed to be used by everyone involved in shaping places: developers, designers, local residents, Council officers and politicians. By developing a shared understanding of what good design means and why it is important, the Guide empowers local residents and stakeholders to engage in the design process and demand more.

The Guide is designed to promote a holistic approach. Design is not a tick box exercise and we expect a contextual approach to guide the process. Each chapter of the Guide deals with a different part of design. It starts with responding to the site and context, followed by developing the structuring principles of the Masterplan, and then explores individual elements of place including streets, buildings and landscape. The final chapters consider sustainability and innovative approaches, building details and use of materials.

Read together the chapters give an overview of the design process from site selection to detailed design. The chapters of particular relevance to individual stages of the planning process are highlighted in table 1.1.

The Guide has been written to support residential development. While it is primarily aimed at supporting major and strategic development, many of the principles will also translate to other development, including smaller housing sites and commercial development.

The majority of recent development has tended to follow a ‘traditional’ style and form. However these developments often do not respond to Cherwell’s vernacular traditions. Chapter 7 sets out detailed information on the design of development that is in keeping with the District’s unique character.

The Guide promotes high standards of design in all areas. Innovation and the sustainability agenda are a key part of this and provide the foundation to creating healthy and sustainable places. As part of this approach, CDC promotes architectural innovation and sees this approach as being particularly appropriate on larger strategic development sites. This approach is set out in more detail in chapter 8.

Relevant chapters	Site selection / outline planning application	Full application	Reserved matters application
1 The importance of high quality design	✓✓	✓✓	✓
2 Cherwell’s special character	✓✓	✓✓	✓
3 Responding to the site and its context	✓✓	✓✓	✓
4 Establishing the structuring principles	✓✓	✓✓	✓
5 Streets and spaces	✓	✓✓	✓✓
6 Building and plot arrangements	✓	✓✓	✓✓
7 Building elevations and details	✓	✓✓	✓✓
8 Innovation and sustainability	✓✓	✓✓	✓✓

Table 1.1 Chapter relevance

✓✓ highly relevant
 ✓ relevant

1.3 The design and planning process

Good design is a collaborative process. Scheme promoters and their design teams will be expected to engage with council officers early in the process through the pre-planning application process.

The Council encourages pre-application engagement before a site is purchased as this provides an opportunity to establish and agree the brief for the site that will inform development value assumptions.

Early engagement with the Council will help to identify potential issues and uncertainties early on in the design process and therefore avoid delays in the application and help provide more certainty once an application is submitted.

For major and strategic sites, Planning Performance Agreements (PPA) are strongly recommended, where common goals, design standards, resources and delivery targets can be agreed.

The Council strongly encourages public engagement throughout the design process. Design review is also seen as an important part of the planning process. Further information on this can be found in **Appendix G**.

The preparation of site specific guidance is often required for most large sites, including design codes and development briefs:

- Design codes provide a clear design framework and vision for the site and ensure overall coordination and consistency between areas. Design codes should provide clear performance criteria for streets and public realm, building form, materials and details
- Development briefs are Council led documents, which set out clear aspirations for site assembly and design. These documents are particularly useful in promoting a development vision for complicated brownfield sites in multiple ownerships

Further information on these is provided in **Appendix G**.

Figure 1.1 explains the required process from site selection to reserved matters application and the points at which engagement with the Council should take place as a minimum.

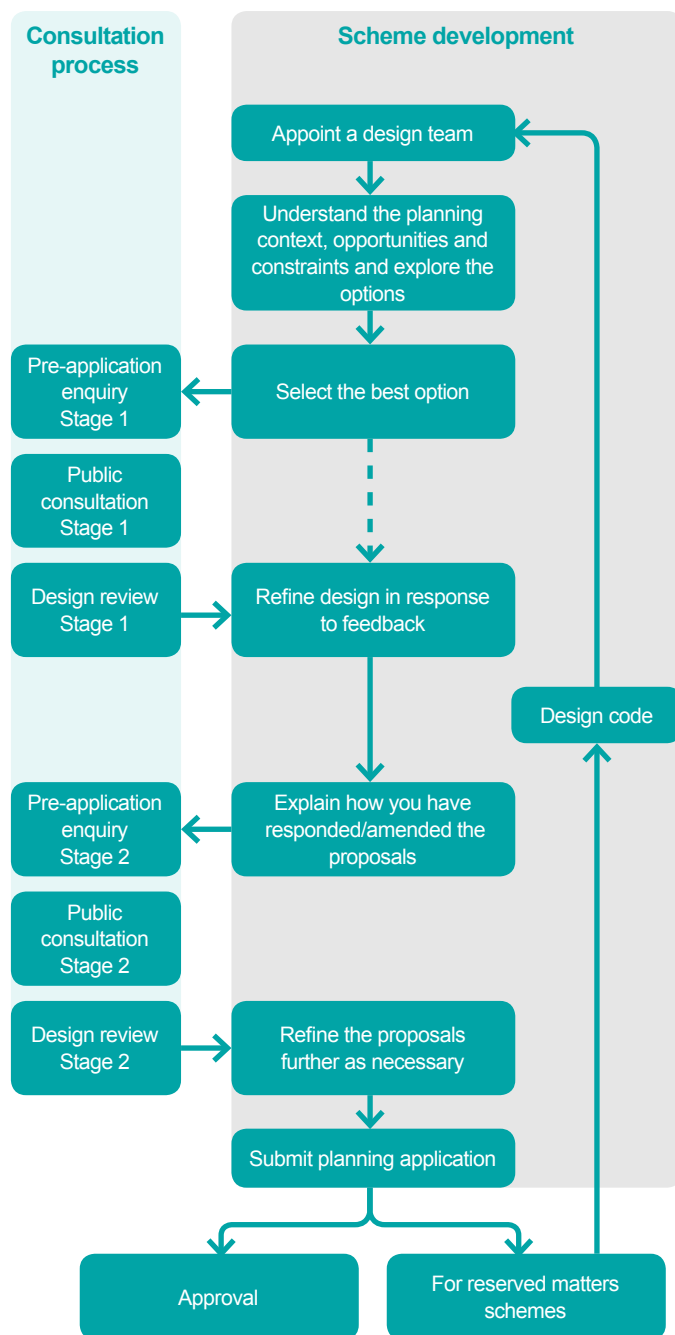

Figure 1.1 Process diagram for outline and full planning applications

1.4 Policy background

The requirement for high quality design is instilled in Local and National planning policy and supporting guidance.

Relevant policy and sources of further guidance are highlighted in each chapter of this report. A full reading list is provided in **Appendix A**.

National policy and guidance

National Planning Policy Framework (NPPF) 2012

The Government's NPPF is based around a presumption in favour of sustainable development of which good design is a key aspect.

The key message is that development should contribute positively to making places better for people though establishing a sense of place in response to local character and history. It clearly states that permission should be refused for development of poor design quality. The NPPF specifies that Local Plans should develop robust and comprehensive policies that set out the quality of development that will be expected within their area. Further explanation of the NPPF policies on design is provided in the supporting online publication **Planning Practice Guidance**.

National design guidance

National design guidance documents which provide useful background reading and further detail relating

to the design process include:

- The Urban Design Compendium, English Partnerships (2nd Edition 2007) and Urban Design Compendium 2, English Partnerships (2007)
- Manual for Streets, DfT/DCLG (2007) and Manual for Streets 2, DfT (2010)
- Car Parking: What Works Where, English Partnerships (2006)
- Building for Life 12, Design for Homes (2012)

Local policy and guidance

Cherwell District Local Plan 2011-2031 Part 1, 2015

The adopted Local Plan states,

“We will ensure that what we approve for development, whether commercial premises or housing, is of the highest design and building standards.” (Local Plan, Foreword).

The Design Guide is being prepared in response to Policy ESD 15: The Character of the Built and Historic Environment of the Local Plan. The headline policy states:

“Successful design is founded upon an understanding and respect for an area’s unique built, natural and cultural context. New development will be expected to complement

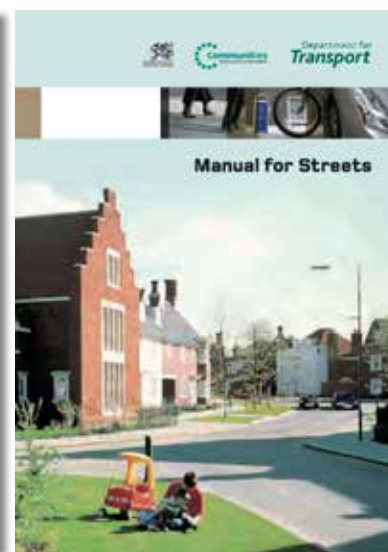
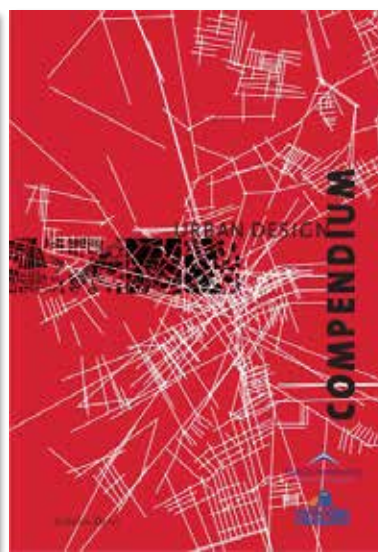

and enhance the character of its context through sensitive siting, layout and high quality design. All new development will be required to meet high design standards. Where development is in the vicinity of any of the District's distinctive natural or historic assets, delivering high quality design that complements the asset will be essential."
(Local Plan, page 117).

The full wording of Policy ESD15 is provided in **Appendix B**. The Design Guide provides explanation and guidance on the meaning of the Local Plan policies in relation to design and once adopted as a Supplementary Planning Document will be a material consideration in the determination of planning applications.

Further policies relating to design are to be included within Part 2 of the Cherwell District Local Plan.

Neighbourhood Plans

Once made Neighbourhood plans are made part of the District's Development Plan and will be used in the determination of planning applications within the area / Parish. They typically provide local policy relating to character, design, mix and location of development.

Adopted Neighbourhood plans

- Bloxham (2016)
- Hook Norton (October 2015)

The following neighbourhood plans are in preparation:

- Adderbury
- Deddington
- Merton
- Mid-Cherwell
- Stratton Audley
- Weston on the Green
- Bodicote

County and District design guidance

Sources of Cherwell planning guidance relating to design which are material considerations when determining planning applications include:

- Conservation Area Appraisals
- Supplementary Planning Documents – site specific and District wide
- Informal planning guidance

A list of current guidance documents is available on Cherwell District Council's website.

Oxfordshire County Council

The County's 'Residential Road Design Guide', Second Edition, 2015 provides guidance on the design of streets across Oxfordshire and emphasises the importance of designing layouts which prioritise people before cars.

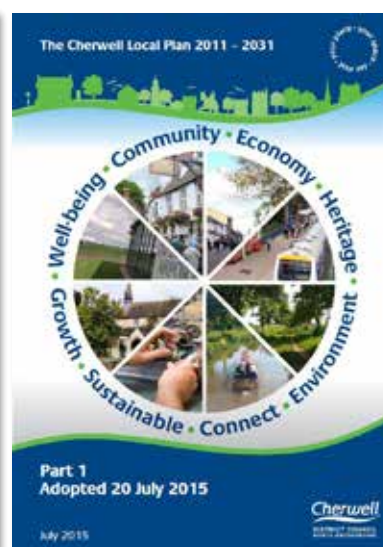

1.5 Abbreviations

Throughout the document the following abbreviations are used:

Draft Cherwell District Design Guide (this document)
= the Guide
Cherwell District Council = CDC
Oxfordshire County Council = OCC

2 CHERWELL'S SPECIAL CHARACTER



- 2.1 The evolution of the District**
- 2.2 The larger settlements**
- 2.3 Countryside Character Areas**

Cherwell's towns and villages have evolved in response to their landscape, movement and social contexts.

This chapter provides a summary of the distinctive characteristics we see today in different parts of the District. It should be used as a starting point for more detailed, site specific analysis which is the first step towards creating a locally distinctive development which sits comfortably alongside its established neighbours.

New development in Cherwell should promote:

- Development informed by an understanding of the historic evolution of the District
- The creation of new places which fit well with the pattern and character of local towns and villages
- Development which is locally distinctive and reinforces the different characters of the north and south of the District
- Development which is located appropriately in response to landscape and topography
- Use of appropriate local materials and detailing (see also chapter 7)
- Or a truly innovative approach to architecture and design

New development should avoid:

- The creation of 'anywhere places' which do not reflect local character
- Inappropriate settlement patterns, architecture and materials
- An awkward relationship between new and old
- The use of superficial details to add character

Please refer to the following chapters for supporting information:

- **Chapter 3:** For details of how site specific analysis should be undertaken
- **Chapter 4-7:** For guidance on how the understanding of local character should inform the masterplan and detailed design decisions
- **Chapter 8:** For guidance on sustainability considerations
- **Appendix C:** List of Conservation Areas within the District

Further reading:

- **Countryside Design Summary, 1998, CDC:** A detailed characterisation study of the District's settlements with particular focus on the rural villages
- **Oxfordshire Wildlife and Landscape Study:** <http://owls.oxfordshire.gov.uk>. A detailed classification of the District's landscape character
- **Colour Palettes, 1996, Studio REAL:** A detailed guide to traditional materials and colour palettes used in different parts of the District.
- **Conservation Area Appraisals, CDC:** Provides detailed character analysis and guidance for each of the District's conservation areas
- **Landscape Character Sensitivity Assessment, 2017, CDC:** Provides an assessment of landscape sensitivities across the district
- **Category 'A' Villages Village Analysis, 2017, CDC:** Provides an analysis of key issues associated with category A villages

2.1 The evolution of the District

2

Local planning policy emphasises the importance of reinforcing Cherwell's local distinctiveness. New development should sit comfortably alongside the established townscape and landscape character of the local area and be unmistakably 'of Cherwell'.

This chapter is intended to assist with the understanding of local character by summarising the key characteristics of the District's three larger settlements and rural areas. It should be used as a reference when undertaking site specific analysis to inform the design process.

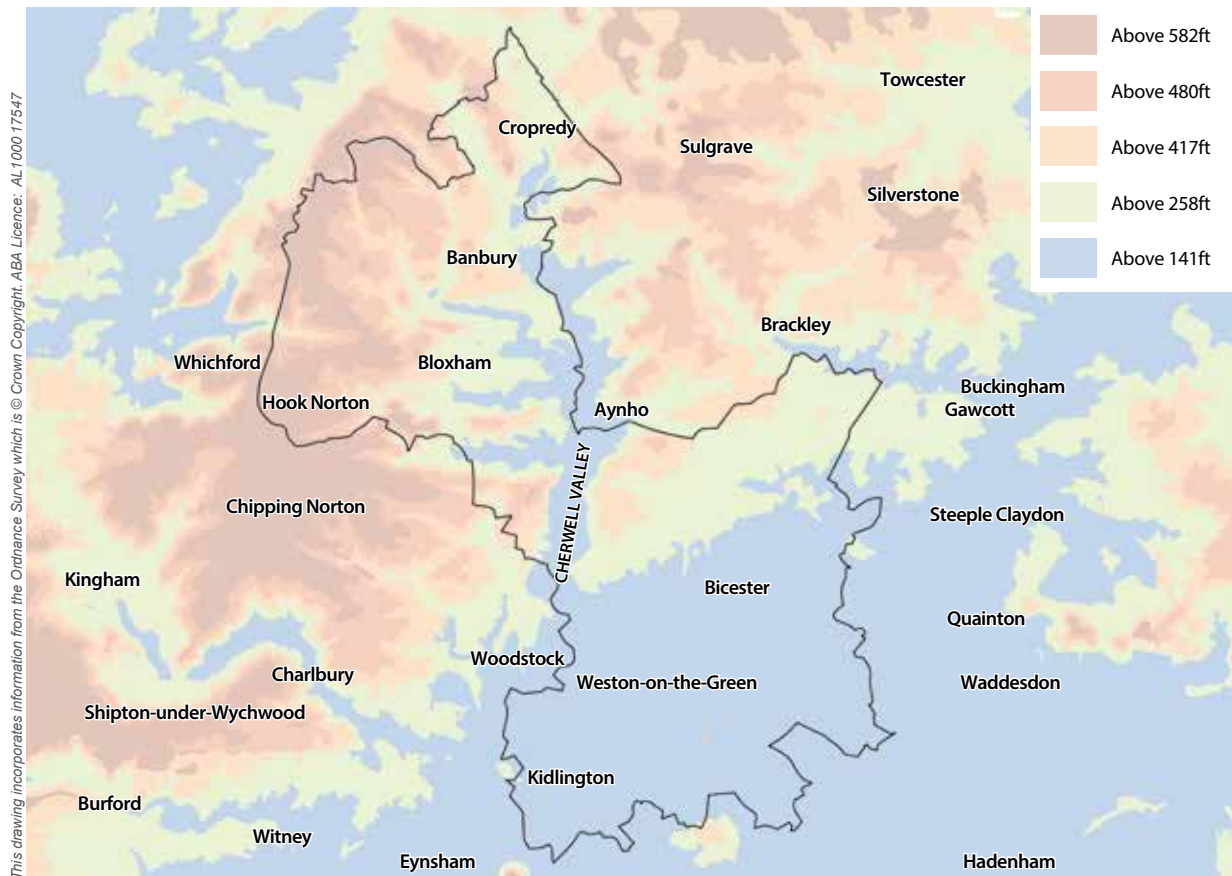

Figure 2.1 Topography map (derived from Ordnance Survey data)

Growing from the land

In an area of Oxfordshire rich in natural resources, Cherwell has been settled from the earliest times. The District takes its name from the River Cherwell, running north to south through the District.

The distinctive character of the District has evolved slowly over the centuries and owes much to its landscape and underlying geology which have directly influenced the character of the built environment. The majority of building materials were sourced from the landscape; buildings were constructed of locally quarried stone with roofs of locally grown thatch. The resulting townscapes are unique to each local area and have a strongly defined character.

Outside the central valley the District can be broadly divided into two character areas to the north and south:

- To the north and north-west, the District is defined by upland plateau, consisting of rolling hills and steep valleys of ironstone geology. Villages in this area are distinguished by their ochre ironstone walls. Banbury sits at the heart of the ironstone north
- The south-east consists of gently rolling limestone plateaux, with large areas of woodland and historic parkland. The south is mostly low lying, based on clay. Villages across the south make use of the cooler toned limestone as the primary building material. Bicester and Kidlington are larger settlements in the south

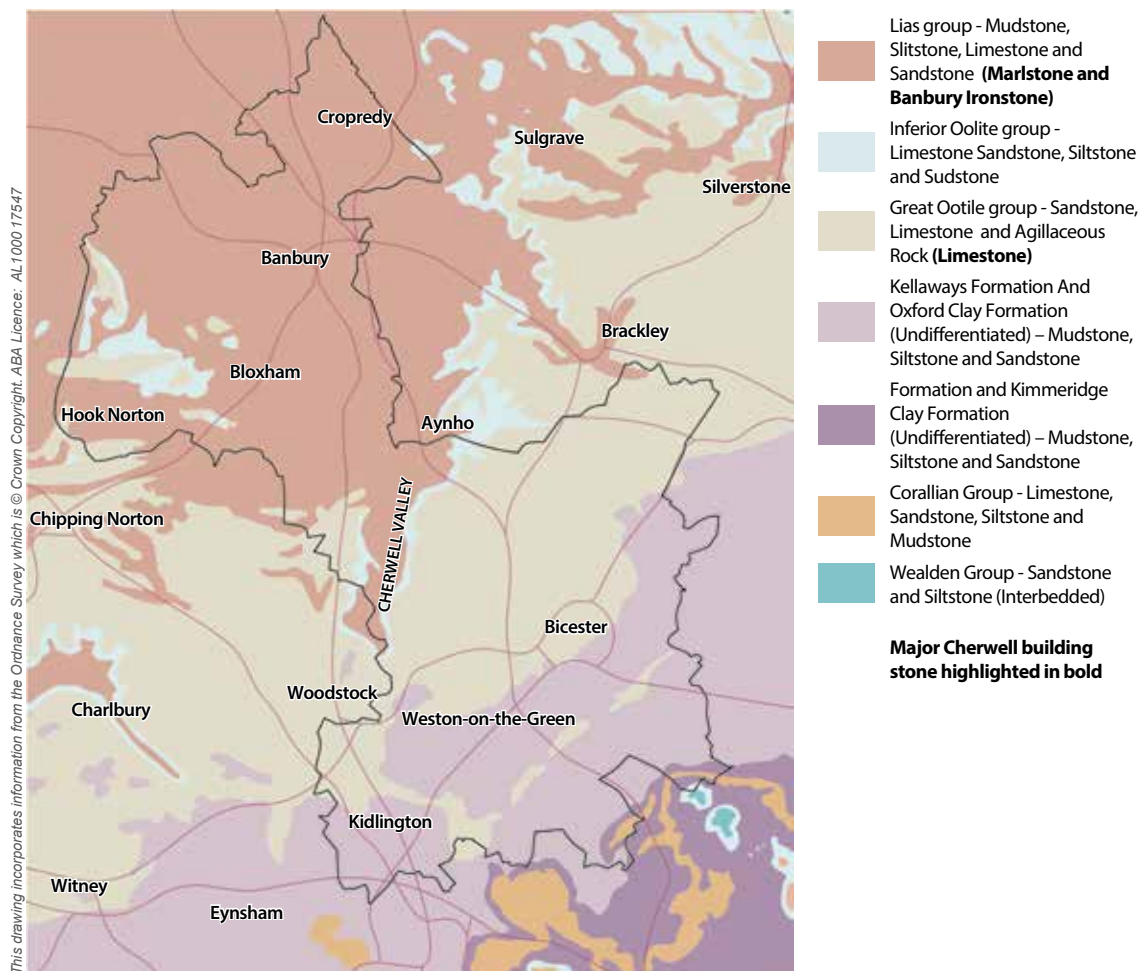

Figure 2.2 Geology map (derived from British Geological Survey mapping)

The railways and Oxford Canal had a significant influence on settlements along their routes. New development in places such as Banbury, took advantage of access to materials such as red brick and Welsh Slate.

Today, Cherwell is an area of growing contrasts. The market towns of Banbury and Bicester which grew as a focus for trade continue to be the primary settlements and have developed an urban character as a result of rapid growth in the twentieth century. The village of Kidlington, the third largest settlement in the District, does not have the status of a market town, but also experienced rapid twentieth century growth as a result of its proximity to Oxford.

The majority of the District, however, retains a rural character. Many of its 72 villages are of a small scale, with distinctive historic cores. They continue to rely on the larger villages and market towns for higher order facilities, retail and employment opportunities.

The high quality of the District's townscapes is reflected in the designation of 60 conservation areas, with over 2,300 listed buildings and dozens of scheduled ancient monuments. The designated historic and natural features of the wider countryside include registered parks and gardens, battlefields and nature reserves.

Appendix C contains a list of Conservation Areas. These are important documents and are a material consideration in planning applications.



Ironstone villages of the north - Bloxham (top) and Adderbury (bottom)



Limestone villages of the south- Islip (top) and Fringford (bottom)

Implications for new development

Where there is a strong, distinctive local character in the surrounding settlement it is expected that new development will be in keeping. Local character should be reflected in all aspects of design from the masterplan layout to building typologies, materials and detailing. This is particularly important for village development sites or small scale infill within historic urban areas. Often these areas are within Conservation Areas or their settings in which case the detailed guidance provided in Conservation Area Appraisals also applies.

Development at the edge of the larger villages and towns including Banbury, Bicester and Kidlington should reflect the distinctive characteristics of the settlement and the wider Character Area in which the settlement is located. Twentieth century housing estates of a generic character and poor design should not be taken as a precedent.

2.2 The larger settlements

2

Banbury

Banbury is a market town of around 44,000 residents, located within the ironstone north of the District. Its earliest origins date from the Saxon period. As early as the seventh century, a settlement developed at the junction of the two ancient roads of Salt Way and Banbury Lane on the west bank of the River Cherwell.

By the mid-thirteenth century the market and associated industries had begun to prosper, becoming an important centre for the wool trade. Transport links continued to support the town's prosperity with the arrival of the Oxford Canal in 1778 and railways in 1850 and it developed a strong industrial base.

Banbury's central historic core remains relatively intact with a medieval pattern of narrow streets, lanes, market squares and burgage plots. The civic buildings date from the eighteenth and nineteenth century. Early

buildings are constructed from local Hornton ironstone and other local ironstones, with locally produced red brick with a soft tone used from the mid-eighteenth century onward.

The adjoining suburbs dating from the eighteenth and nineteenth centuries, have a grid plan and consist of two or three storey terraced houses. Detached, semi-detached houses and large villas of the nineteenth and early-twentieth century are on a grander scale, with larger plots and mature trees making a valuable contribution to the streetscape.

In comparison to Bicester and Kidlington, Banbury's twentieth century expansion was more gradual and has greater coherence. In outer Banbury, the majority of the built environment was developed during the second half of the twentieth century, particularly 1950s to 1970s to house overspill population from London

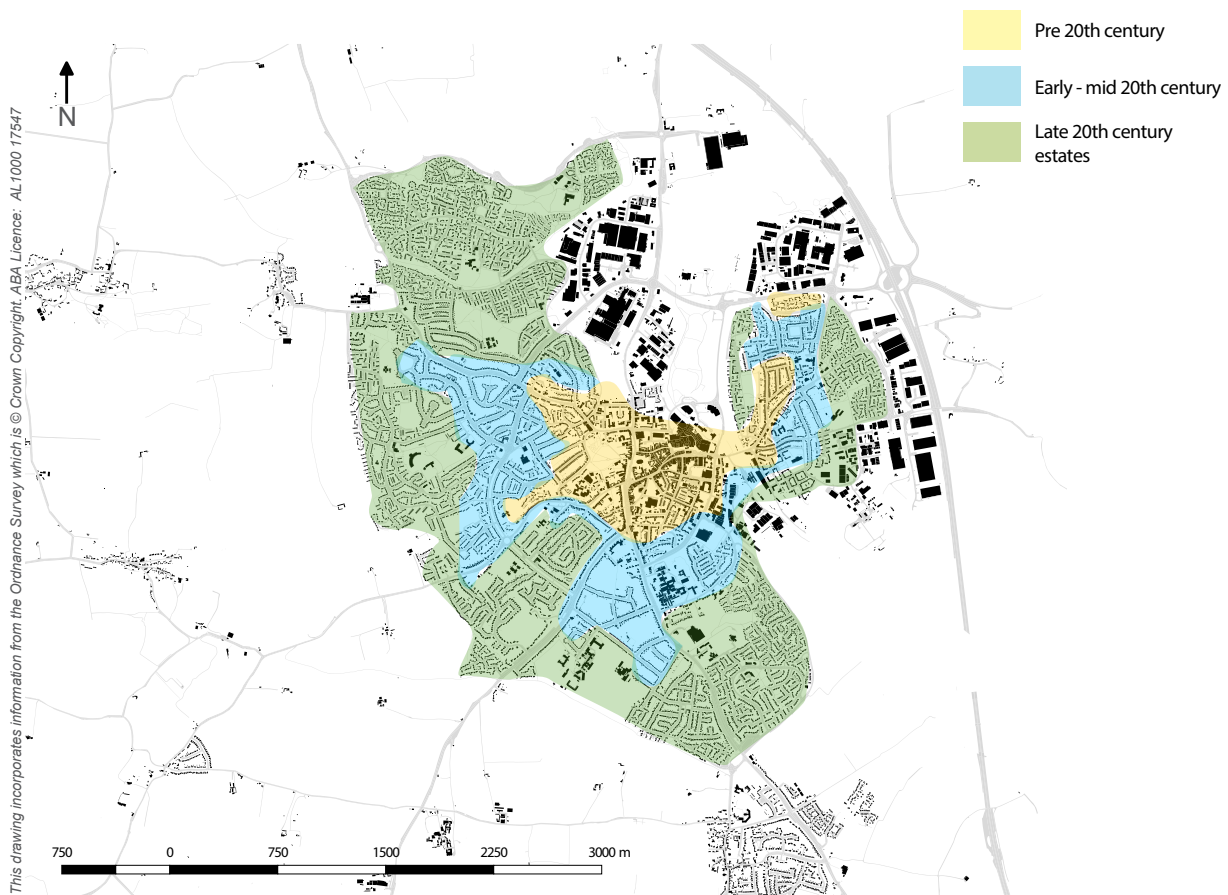

Figure 2.3 Banbury

and the West Midlands. The growth accelerated after the 1970s with the completion of the M40 which gave fast and direct access to London and Birmingham.

The Council took a strong lead in the design of the later suburbs, which follow garden suburb principles. In contrast, large estates developed on the periphery of the town offer little in terms of local distinctiveness.

The town remains both walkable and cyclable, with a clear sense of order and relationship between residential areas and the town centre. It is important that new development at the edge of town continues to relate well to the centre and reflects the building traditions of the town's more distinctive residential areas. Key characteristics include:

- A compact medieval core, defined by a clear network of streets and defined frontages. There are a wide range of building styles reflecting the development and redevelopment of the area over the centuries, but harmony is established through the consistent rhythm of the plots, scale and materials
- Victorian and Edwardian suburbs with greater consistency; typically terraced properties, constructed in local brick with a harmony of plots, scale and details
- Many of the mid 20th century suburbs also have a sense of order established along Garden Suburb principles, with tree-lined avenues and stretches of terrace or semi-detached properties set back from the street behind clearly defined thresholds
- Some late 20th century development has a weak urban form and lacks local distinctiveness



Some 20th century developments in Banbury have a weak urban form and lack local distinctiveness



Pre-20th century development in Banbury - Old Parr Road (top), King's Road (middle), South Bar Street (bottom)

Bicester

Bicester is a rural market town, located in the south east of the District. Established on a river crossing of the River Bure, an ancient route between Oxford and Buckingham, it sits at the northern edge of the Otmoor lowlands next to a band of limestone and Cornbrash. The river and a railway embankment provide variation to the otherwise flat topography. Graven Hill, located at the south east of town, is the only topographic feature of note.

Bicester's historic core is still the commercial centre and the civic heart of the town. It formed from the coalescence of three settlements: King's End, Market End and Crockwell and was influenced by the route of the River Bure. Aside from redevelopment in the centre, it changed little through the eighteenth to mid-twentieth centuries.

The bulk of the historic core consists of two or three storey vernacular buildings of limestone rubble or red brick with some re-fronted timber framed buildings along the old London Road. Building frontage in the town centre is continuous; strongly defining the public realm.

The green spaces within Bicester provide valuable relief from the densely built town centre. The contribution that mature trees make to the townscape is immensely valuable.

The shape of the town altered in the twentieth century with the establishment of the RAF station and later the Ordnance Depot. Housing estates were developed around the periphery of the historic core. These are well cared for, but poorly connected to the centre and lack local distinctiveness. From a population of 5,512 in 1961, numbers grew to an estimated 32,640 in 2011.

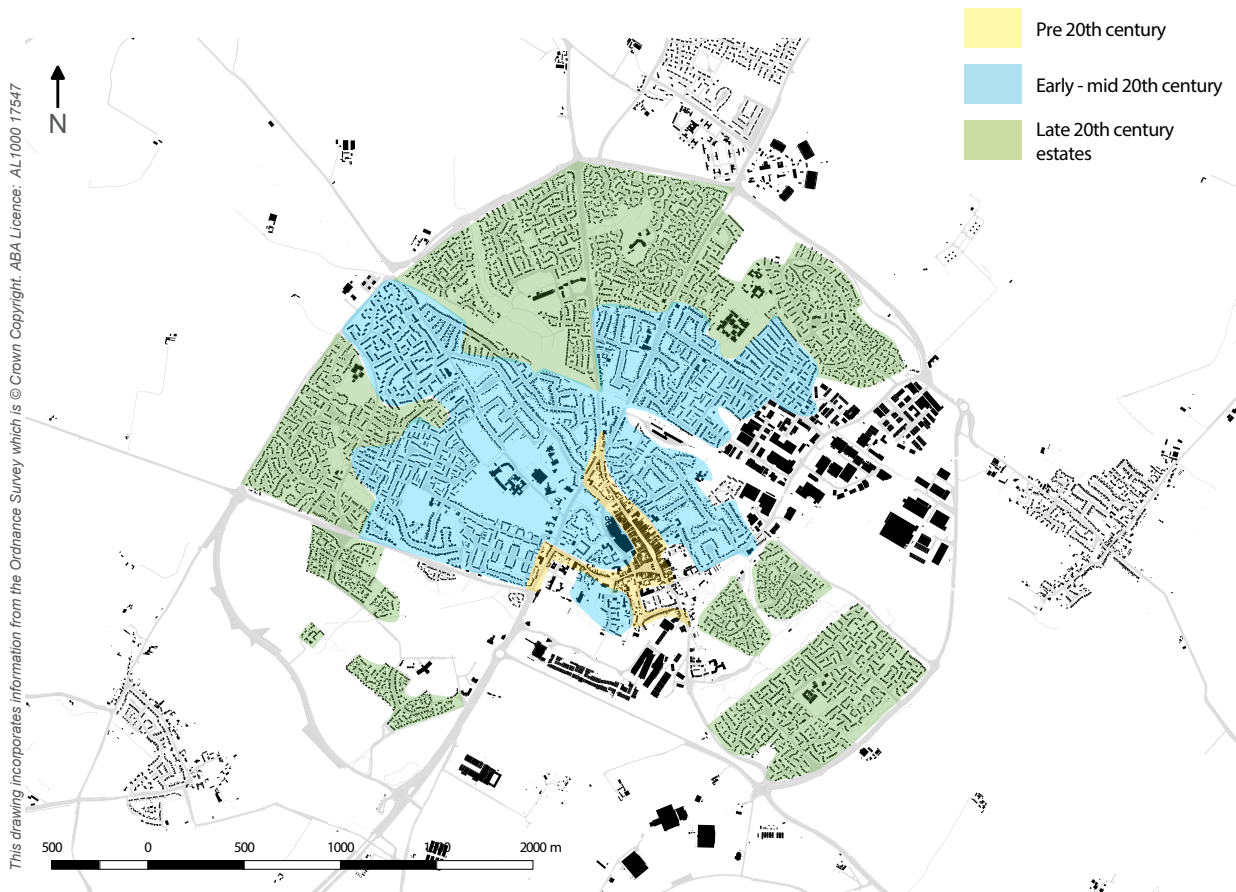

Figure 2.4 Bicester

Key characteristics include:

- A compact medieval core, defined by a clear network of streets and defined frontages. There are a wide range of building styles reflecting the development of the area over the centuries, but harmony is established through the consistent rhythm of the plots, scale and materials
- Small areas of Victorian and Edwardian expansion are typically terraced, constructed in local brick
- Much of the 20th century suburbs date from the post war era. These are frequently based on cul-de-sac structures, limiting their sense of connection with other areas. The layout and design of houses does little to reinforce local distinctiveness. These areas, while well loved by residents, are not appropriate for replication in new development

The perimeter of Bicester is undergoing transformation with significant new development planned in a series of distinctive neighbourhoods. RAF Bicester is becoming an interesting hub combining new technologies with heritage, while Graven Hill is to develop a distinctive character as a result of the council-led self-build programme. To the north-west, Bicester Eco-town is demonstrating new sustainable technologies and new urban forms. To the south-west and south-east housing growth areas are more normative in their design.



Sustainable exemplars

The town of Bicester is undergoing significant change and growth. This is reflected in its designation under a number of Government funded initiatives (Garden Town, Eco-town and Healthy New Town) which aim to provide new homes with a focus on innovative design and high levels of sustainability.

The guiding principles of good urbanism contained within this Guide must underpin all these proposals, creating well-connected, distinctive, safe and attractive places which engender civic pride and a sense of community. However, the Guide recognises that within sustainable exemplars, the development of new buildings typologies, architectural styles and materials may be appropriate. Bespoke design solutions will be agreed in consultation with the Council. Chapter 8 provides further details on innovation and sustainability.

Bicester - Priory Road (top), Church Street (middle), Elmbrook, North West Bicester (bottom)

Kidlington

Kidlington is an enlarged village, located in the Clay Vale of Otmoor, between the attractive green corridors of the River Cherwell and Oxford Canal. Kidlington emerged as a dispersed group of medieval hamlets focused on and around St Mary's Church and the Town Green in the east and Kidlington Green to the west. The remaining historic streets are built predominantly of Cotswold limestone with some later red brick buildings.

With the arrival of the canal in the eighteenth century and the railway in the nineteenth century, the settlement began to expand westwards. Rapid growth came in the twentieth century in response to Oxford's population pressure. Ribbon development of semi-detached and bungalow properties along Oxford to

Banbury Road and on large plots around the Moors was followed by the development of a 'Garden City' to the south led by the District Council and later on the growth of cul-de-sac based estates which limit east-west connectivity.

Unlike Banbury and Bicester, Kidlington does not have a medieval or Victorian civic centre. The village centre dates mainly from the late-twentieth century and relates poorly in character and scale to the pockets of remaining historic residential streets, some which are now designated as Conservation Areas.

Future development within Kidlington should look to strengthen the character of the village, and create a distinctive heart to the settlement in the village centre.

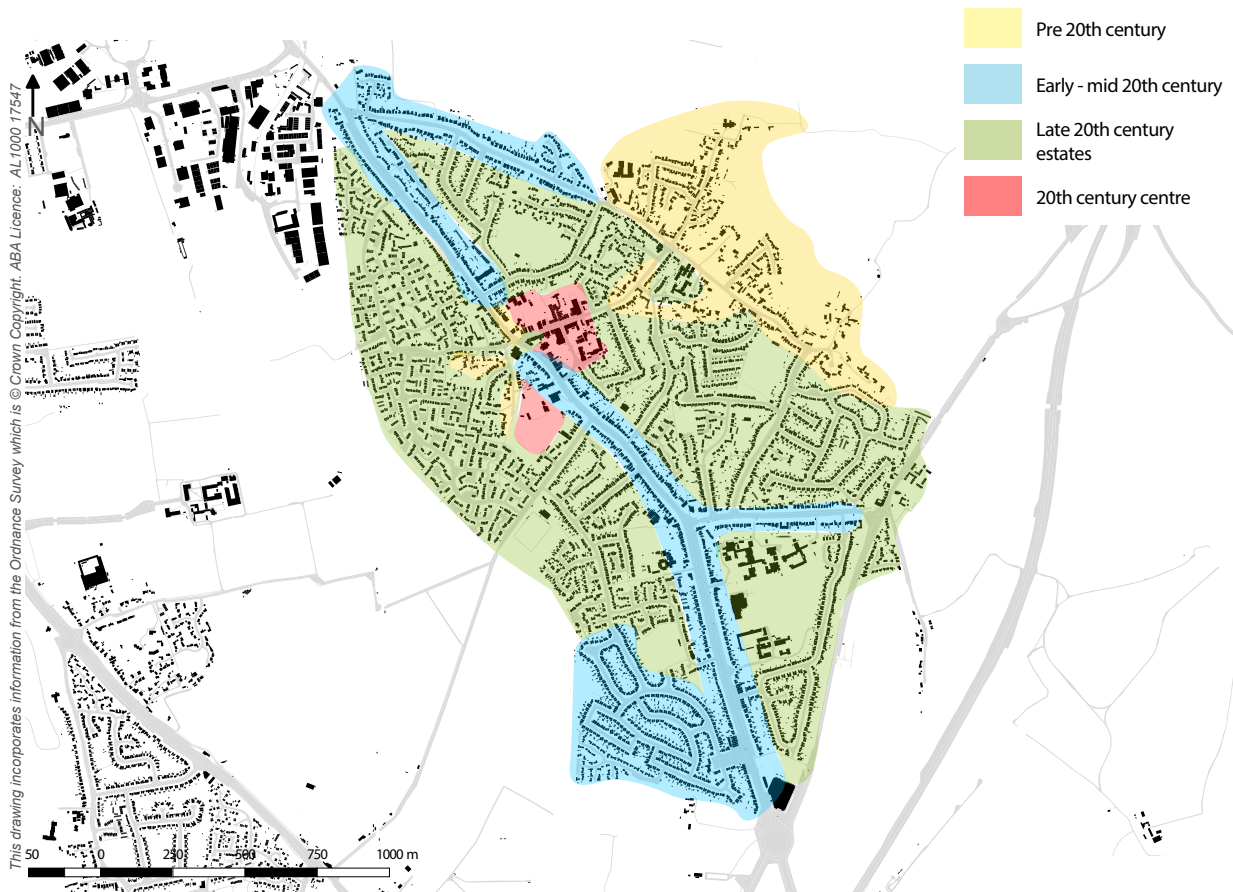

Figure 2.5 Kidlington

Key characteristics include:

- Small pockets of historic development
- 20th century centre which lacks character and consistency
- Many of the suburbs have been guided by Garden Suburb principles, with tree-lined avenue and stretches of terrace or semi-detached properties



Kidlington village centre (top), low rise ribbon development on Oxford Road (bottom)

Franklin Close (top), The Moors (middle), typical Garden City housing (bottom)

2.3 Countryside Character Areas

2

The character of the district varies from north to south, with ironstone to the north and limestone to the south. There are more subtle distinctions which are described in the Council's Countryside Design Summary, CDC (1998).

This classifies the District into four geographic character areas reflecting the influence of landscape and geology (figure 2.6):

- The Cherwell Valley
- The Iron Stone Downs
- The Ploughley Limestone Plateau
- The Clay Vale of Otmoor

A summary of the distinctive characteristics of each area is provided in table 2.1. The Countryside Design Summary notes that variation occurs at the more local level, from village to village, street to street and building to building, but each area displays an overall character which distinguishes it from the others.



Cherwell Valley



Ironstone Downs



Ploughly Limestone Plateau





Clay Vale of Otmoor





Figure 2.6 Cherwell District countryside character areas and heritage assets

The north and central valley

2

	Cherwell Valley	Ironstone Downs
		
Location	Runs north-south across the District following the River Cherwell.	Northern half of the District to the west of the Cherwell Valley.
Landscape	<p>To the north, a wide rolling valley dissecting the Ironstone Downs with a flat floor which floods seasonally. The valley narrows south of Banbury across limestone beds then flattens out over the Clay Vale.</p> <p>The Oxford Canal, Banbury to Oxford Railway and M40 are significant features of the valley floor.</p>	<p>An upland plateau-like landscape of mixed farmland, incised by very steep and often narrow valleys in the north. The land rises to the west forming an upland ridge with extensive views. The south has steeply sided, convoluted valleys with narrow valley floors and rolling, rounded hill lines.</p> <p>The Ironstone Downs consists of marlstone rock beds overlying middle and lower lias clays.</p>
Settlement patterns	<p>Settlements are mostly located on the valley slopes and have agricultural origins. Some have been influenced by the canal and railway.</p> <p>Linear settlement form is most common reflecting growth along a main movement route. Others are nucleated around road junctions. Village streets are mainly open in character with a variety of open spaces.</p>	<p>Numerous small, closely spaced settlements of agricultural origin, with larger villages located to the south.</p> <p>Villages are positioned in valley locations either on the valley sides, at the head of the valley or on the brow of the hill. Villages are generally only visually prominent where the valleys are open and wide.</p> <p>Villages have linear or nucleated forms or enclose areas of open land.</p>
Buildings	<p>Mainly two storey terraced or detached cottages, facing the streets and close to the kerb or behind stone walls. Steeply pitched roofs.</p> <p>Front gardens are uncommon.</p>	<p>Mainly two storey terraced and detached houses, the majority of which face the street. Roof pitches are steep with brick stacks on the ridge line.</p> <p>Buildings are often located at the back of pavement or set back behind ironstone walls. Trees and hedgerows are important features of the streetscene.</p>
Materials	<p>Ironstone from Clifton northwards, limestone to the south. Some villages have a mixture. Welsh slate and engineering brick also evident.</p> <p>Dark toned plain slate and tile roofs or thatch.</p>	<p>Ironstone walling except at Duns Tew where limestone predominates. Early nineteenth century brick buildings in villages close to Banbury.</p> <p>Thatch and stone slate roofs, often replaced with plain dark grey slates, tiles and Welsh slate.</p>

The south

	Ploughley Limestone Plateau	Clay Vale of Otmoor
		
Location	Central part of the District, east of the Cherwell Valley.	Southern part of the District.
Landscape	<p>A number of exposed upland plateaux in the north and west dip gently into rolling undulations and shallow valleys to the southeast. There are extensive areas of woodland cover.</p> <p>White limestone in the north gives way to cornbrash further south, both of the great oolitic group.</p>	<p>A low lying clay vale which rises gently to the north and west, and sharply to the south to form the Oxford Heights.</p> <p>The land is waterlogged, although extensive drainage has enabled more than half of the land to become arable farmland.</p> <p>Otmoor is an important grassland habitat designated a Site of Special Scientific Interest (SSSI).</p>
Settlement patterns	<p>Most villages are small and linear in form. They are not prominent in the landscape due to landform and woodland cover.</p> <p>A few villages have a formal unity of design which suggests they are planned estate villages e.g. Kirtlington.</p>	<p>Settlements are mostly located just above the level of the floodplain often on outcrops of cornbrash.</p> <p>Villages are small and generally linear in form. Some have an open, unstructured character with properties set back behind stone walls, gardens and hedges. Others have a tighter, urban structure.</p>
Buildings	<p>A mix of mostly two storey terraced and detached properties, with fairly steeply pitched roofs and brick chimney stacks on the roofline.</p> <p>Buildings face onto streets and public spaces, but larger properties may be set back some distance behind limestone walls. Iron railings are also used.</p>	<p>Mostly two storey detached, with groups of terraces in some villages. Steeply pitched roofs with chimneys on the rooflines.</p> <p>Buildings mainly face streets. Detached properties have a variety of forms and often set back at varying depths from the road producing an irregular street frontage.</p>
Materials	<p>Limestone rubble, coursed and thinly bedded. Red brick. Red and occasionally blue bricks are used for quoins and detailing in 19th century estate cottages.</p> <p>Thatch and stone slate roofs, many now replaced by local clay tile and welsh slate.</p>	<p>Limestone in most of the area. Red brick buildings and detailing also found. Ornamental and whitewashed brickwork is more common across this area.</p> <p>Roofs were traditionally thatched, now mostly replaced with plain dark toned slates and tiles and in some areas plain, red clay tiles.</p>

Reference should also be made to the Oxfordshire Wildlife and Landscape Study. <http://owls.oxfordshire.gov.uk>. This divides the District into 19 landscape types (see figure 2.7) which sit within Natural England's National Character Areas. Landscape and biodiversity guidance is provided for each.

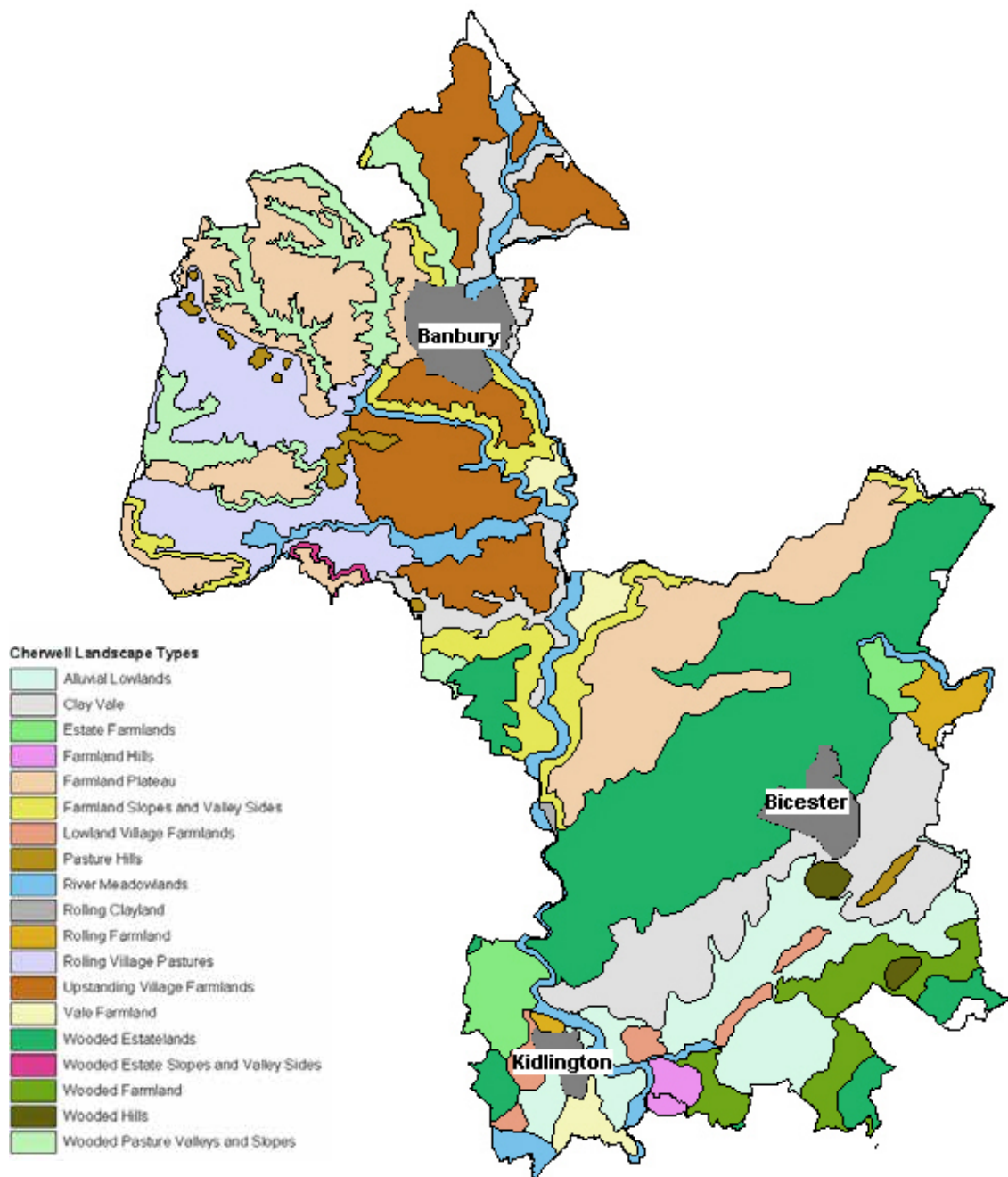

Figure 2.7 Cherwell landscape types (source: OWLS)

3 RESPONDING TO THE SITE AND ITS CONTEXT



3.1 Understanding the site and its context

3.2 Opportunities and constraints

Understanding the characteristics of a site and its wider setting are fundamental to good masterplanning and design solutions.

This chapter explains the process of information gathering, analysis and synthesis leading to a clear understanding of site constraints and opportunities. This should be undertaken in the preparation for outline, full and reserved matters planning applications.

New development in Cherwell should promote:

- Meaningful analysis which is appropriate to the stage and nature of the project and positively informs the project brief and design process
- Designs which are responsive to local conditions, which fit naturally with the landscape and settlement pattern and are distinctive to Cherwell
- Engagement with the Council and local stakeholders during the analysis process

New development should avoid:

- The creation of 'anywhere places' which do not respond to local context
- Analysis which focuses on detail and fails to consider bigger picture issues
- A lack of engagement with Council Officers in the early stages of the design process
- Responding to the wrong context, for example: taking precedent from poor quality development.
- Failure to synthesise the information gathered that leads to a design that does not respond to the issues identified

Please refer to the following chapters for supporting information:

- **Chapter 2:** For a summary of the District's distinctive characteristics and character areas
- **Chapter 4:** For details of how the site analysis should be interpreted in the masterplan and vision
- **Chapter 5-7:** For details of how site analysis should inform the detailed design of streets, plots and buildings
- **Chapter 8:** For guidance on sustainability considerations
- **Appendix A:** List of Conservation Areas within the District

Further reading:

- **Urban Design Compendium, 2007, English Partnerships:** Chapter 2 - Appreciating the Context for further detail on human, environmental and economic factors to consider in site analysis and their relationship to site feasibility testing and vision.

3.1 Understanding the site and its context

Analysis of the site and its context is a fundamental part of the design process. The aim is to understand and respond positively to the site’s characteristics and the surrounding context to create a distinctive place rooted in the local environment.

Every site has a different social, economic and physical context and requires a bespoke design response. It is critical that the development context is understood at the very start of the design process to inform the design brief and commercial decisions relating to site selection. Not all sites will be appropriate for development and initial analysis and consultation with the council will be important in determining a site’s suitability.

The role of analysis is to:

- Establish where you should and shouldn’t build within a site and within a settlement
- Establish important points of connectivity
- Identify site features requiring protection or enhancement
- Identify local townscape and landscape characteristics so that they can be reinforced through the development
- Understand Council, local stakeholder and statutory consultee requirements for the site
- Directly inform the brief for the masterplan and the design solution

Alongside a desk based review of existing documents, the Council will expect to see evidence of site visits and primary analysis of the site and the surrounding area. It is expected that the design team will engage with technical stakeholders including Council Planning Officers to agree the scope of analysis, gather information and discuss the appropriate design response.

It is expected that a robust analysis should be set out within the Design and Access Statement to explain how design decisions have been made.

The extent and breadth of analysis should be appropriate to the size and location of the site (see figure 3.1).

Site analysis should continue throughout the design process with an increasing level of detail as a scheme moves towards implementation.

For example in relation to townscape analysis:
 Outline application: layout informed by an analysis of characteristic street patterns, block and building typologies and relationship to the street, alongside a general exploration of architectural form, character and detail.

Full or reserved matters application: detailed design informed by a detailed analysis of vernacular architecture, local building and public realm materials and details.

Small infill site

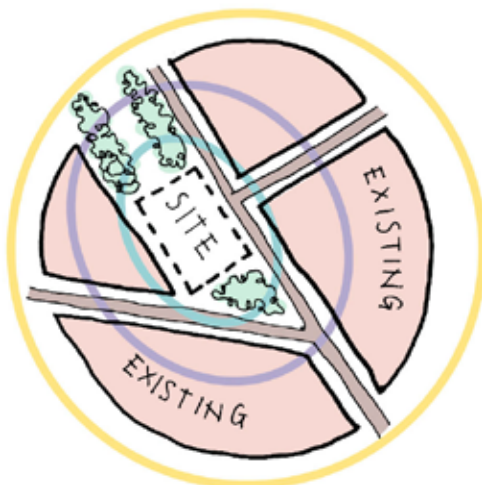

Large edge of town site

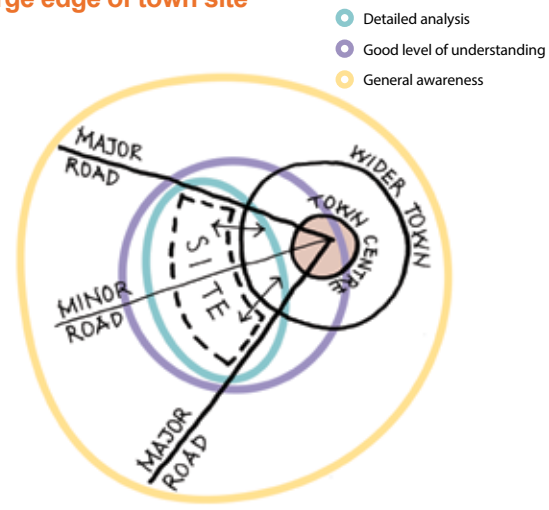

Figure 3.1 Indicative extent of analysis

The table below provides a list of typical topics which should be included in the analysis process, together with likely sources of information. This is not an exhaustive list and should be tailored to the specific site, but can be used as a starting point or aide mémoire. The list of 'Questions to address' provides guidance on how site analysis should be used to inform a synthesis of constraints and opportunities.

Questions in bold are of particular relevance to Full or Reserved Matters Applications.

Planning review and socio-economics	
Details	Planning history of the site Adjacent developments / proposals Relevant planning policy including housing, open space and other land use requirements Neighbourhood plans Demographic characteristics Access to services and facilities
Questions to address:	<ol style="list-style-type: none"> 1. Is the principle of development acceptable in planning terms / is the site allocated in the Local Plan? 2. Is the site located within a neighbourhood plan area? 3. What is the most appropriate mix of uses on the site to meet community needs? <ul style="list-style-type: none"> • housing mix? • new facilities and services e.g. education, healthcare, employment, retail? • open space? 4. Are there adjacent sites which should be considered in a joined-up way? 5. Who should be consulted during the design process and when (e.g. Parish Council, Neighbourhood Forum, adjacent landowners or statutory consultees)? 6. How were previous schemes for the site received by the Council and local community? 7. Can an appropriate scheme be developed given constraints, commercial and operational viability?
Sources of background information	CDC Office for National Statistics

Views and sightlines	
Details	Important views into and out of the site Landmarks
Questions to address:	<ol style="list-style-type: none"> 8. Where are the key views into and out of the site that the scheme should preserve / enhance? 9. Are there sensitive visual receptors e.g. adjacent properties or heritage assets and how should the scheme respond to these?
Sources of background information	Site visits Conservation Area Appraisals

Townscape character	
Details	Settlement evolution and pattern Relevant District Character Area Local street and building characteristics Land use mix Site edge conditions Conservation Areas Heritage assets Archaeology
Questions to address:	10. What District Character Area is the site located within and what are the key characteristics of landscape and townscape? 11. Does the site or context contain designated and non designated heritage or townscape assets (e.g. Conservation Area, listed building, locally listed building designations)? How can these features be preserved and enhanced? 12. Where should development be located within the site to respect the natural limits of the settlement and its historic pattern? 13. Where is the site located within the overall hierarchy of the settlement e.g. centre, edge, standalone? 14. What are the conditions at the edge of the site and how should the scheme respond e.g. housing backing/fronting, open space, woodland, other uses? 15. How might the scheme reflect locally distinctive relationships between buildings and the public realm e.g. extent of frontage, angle of buildings to the street, boundary treatments? 16. How might the scheme reflect locally distinctive building forms, groupings, heights, rooflines and architectural details, wall and surface materials?
Sources of background information	Historic maps CDC Countryside Design Statement Conservation Area Appraisals OCC Historic Environment Record Historic England register of listed buildings CDC for local listings Site visits / surveys

Landscape and topography	
Details	Ecology and Habitat designations Mature trees, Tree Preservation Orders (TPOs) and hedgerows Treebelts and woodlands Watercourses Topography and geology Public open space provision within the settlement
Questions to address:	17. Does the site or context contain protected or important landscapes, habitats or species? How can these be preserved and enhanced? 18. Is there a natural limit to the settlement defined by landscape / topography? 19. How should the scheme work with and make the most of topography and existing landscape features e.g. hedgerows, green corridors, high-points, mature trees on and adjacent to the site?
Sources of background information	CDC Berks, Bucks and Oxon Wildlife Trust (BBOWT) MAGIC website (www.magic.gov.uk) Oxfordshire Wildlife and Landscape Study (OWLS) website Natural England British Geological Survey website Ordnance Survey maps Site ecology/ arboricultural surveys Site visits

Movement network	
Details	<p>Planned transport works</p> <p>Potential access points into the site</p> <p>Distance to public facilities, shops, services and employment uses</p> <p>Existing movement routes through the site and in the surrounding settlement: streets hierarchy, footpaths, bridleways, informal and historic routes</p> <p>Future desire lines</p> <p>Public transport routes and stops</p> <p>Car parking requirements</p>
Questions to address:	<p>20. Where can access be gained?</p> <p>21. Are there capacity constraints in the local highway network which limit the quantum of development or will require new highways infrastructure?</p> <p>22. How might the scheme layout respond to existing and future desire lines e.g. to local shops, schools, open space?</p> <p>23. Are there existing movement routes (roads, footpath, cycle routes etc) which should be retained?</p> <p>24. How can the scheme connect into the surrounding street and footpath/cycleway network?</p> <p>25. How does the site relate to existing public transport routes? Is there an opportunity to route these through the site?</p> <p>26. What is the appropriate amount and arrangement of car and cycle parking within the scheme?</p>
Sources of background information	<p>CDC</p> <p>Local Transport Plan (OCC)</p> <p>Other OCC guidance e.g. parking standards</p> <p>Ordnance Survey maps</p> <p>Public transport operators websites</p> <p>Site visits</p>

Physical constraints	
Details	<p>Flooding – fluvial and surface</p> <p>Noise</p> <p>Smell</p> <p>Utilities corridors</p> <p>Contamination</p> <p>Archaeology</p> <p>Microclimate</p>
Questions to address:	<p>27. Are there existing buildings on the site?</p> <p>28. Do the site levels present any access and construction issues?</p> <p>29. Does the site have access to utilities; are there utilities constraints e.g. easements?</p> <p>30. Are there ditches, ponds and water courses running through the site?</p> <p>31. Is the site at risk of fluvial or surface water flooding?</p> <p>32. What is the appropriate sustainable drainage response to the topography / geology of the site?</p> <p>33. Does contamination within the site constrain development?</p> <p>34. Does the site suffer from noise pollution which constrains development or requires mitigation?</p> <p>35. Are there any smells / air pollution issues which need to be mitigated?</p> <p>36. Are there any earthworks / archaeological constraints that need to be investigated / surveyed?</p> <p>37. Are there any microclimate issues that need to be considered in relation to wind, overshadowing etc.?</p>
Sources of background information	<p>Environment Agency</p> <p>CDC Strategic Flood Risk Assessment</p> <p>Statutory undertakers</p> <p>Utility providers</p> <p>Site survey</p>

3.2 Opportunities and constraints

Analysis should be sifted and synthesised to draw out the key constraints and opportunities and inform the brief for the masterplan.

The site analysis process should be broad and layered, fed by multiple sources of information (see figure 3.2). Following information gathering and initial analysis, the issues and details which are important for the scheme are drawn out.

The key findings of the analysis process should be communicated in an opportunities and constraints plan.

This should:

- Overlay key physical constraints and areas unsuitable for built development
- Identify key features of the site and context
- Identify opportunities for reinforcing existing features as part of a green infrastructure strategy
- Identify site access opportunities and connections to the surrounding movement network
- Identify initial design opportunities in response to site conditions including the potential extent of development

The project brief should be refined in light of the opportunities and constraints analysis, which forms a robust foundation for the masterplan.

Figure 3.2 Site analysis process

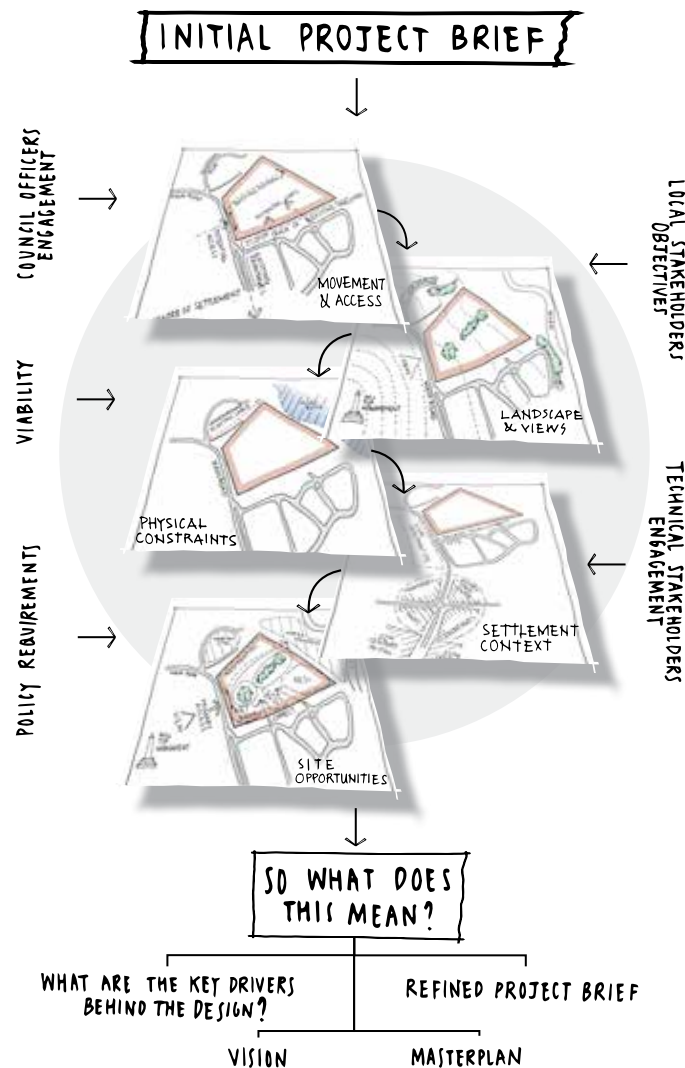

4 ESTABLISHING THE STRUCTURING PRINCIPLES



- 4.1 The role of the masterplan**
- 4.2 Flexible design briefs and viability**
- 4.3 Vision and character**
- 4.4 Land use mix**
- 4.5 Masterplan block and street structure**
- 4.6 Relationship to the existing settlement**
- 4.7 Landscape structure**
- 4.8 Density**
- 4.9 Sustainability considerations**

This chapter explains the role of the masterplan in establishing the spatial principles for the scheme considering character, landscape, land use, movement and sustainability objectives.

It is of particular relevance to the preparation of full and outline planning applications.

It should be read in conjunction with chapter 3 'Understanding the site' which explains the process of opportunities and constraints analysis. It must be clear how the masterplan has responded to this analysis.

New development in Cherwell should promote:

- A robust masterplan structure which is grounded in a solid understanding of the constraints and opportunities of the site and its setting
- A clearly articulated vision for the character of the scheme to establish a locally distinctive place which sits comfortably with its surroundings
- Connectivity between the masterplan and the surrounding settlement.
- A land use mix which provides community focus, including public buildings, that directly responds to local needs and is in line with local planning policy
- Continued engagement with the Council and local stakeholders as the masterplan is developed

New development should avoid:

- A disconnection between analysis and masterplan layout and a lack of creativity when responding to site constraints
- A lack of a clear and distinctive vision for the character of place to be created
- Layouts which fail to connect and respond to the existing settlement pattern, street network and context
- Schemes which block future settlement expansion
- Fixing the development brief before the masterplan can be objectively tested

Please refer to the following chapters for supporting information:

- **Chapter 2:** For a summary of the District's distinctive characteristics and character areas
- **Chapter 3:** For details of how site analysis should be undertaken to inform the masterplan
- **Chapter 5-7:** For guidance on detailed design relating to streets, plots and buildings. An awareness of these considerations should inform the masterplan
- **Chapter 8:** For guidance on sustainability considerations

Further reading:

- **Urban Design Compendium, 2007, English Partnerships:** Chapter 3, Creating the Urban Structure, further detailed guidance on land use mix, urban structure, density, open space typologies, sustainability, urban block size and arrangement and legibility
- **Creating Successful Masterplans, 2004, CABI:** Detailed guidance on the masterplanning process, the role of the client and project brief, different types of masterplan and their components
- **Manual for Streets, 2007, DfT/DCLG:** Chapter 4 Layout and connectivity, detailed guidance on walkable neighbourhoods, layouts and appropriate street forms
- **The SuDS Manual (C753), 2015, CIRIA www.susdrain.org:** Detailed guidance relating to the design of sustainable drainage systems
- **Site layout planning for Daylight and Sunlight: a guide to good practice, 2011, BRE:** Detailed guidance on the daylighting of buildings, public spaces and private amenity space

4.1 The role of the masterplan

The masterplan sets the structuring principles of the development and its relationship to the surrounding area. It should be clear how the site analysis has informed the masterplan.

Masterplans are a critical part of the design of major and strategic sites and will be expected to form part of a planning application for all development over ten units.

The masterplan:

- Establishes the spatial principles of the scheme including movement, landscape, infrastructure and land use
- Is a response to the initial brief, the site constraints and opportunities
- Is a co-ordination tool which shows how each phase relates to the wider scheme
- Tests the development capacity of the site and supports the preparation of development appraisals, funding and implementation strategies
- Is an evolving strategy which is refined throughout the design process in response to ongoing analysis, consultation and detailed design work

The creation of a robust masterplan is an iterative process, involving testing, refinement and consultation. The Council will expect to be involved in the following stages of masterplan development which should be clearly evidenced in the planning submission:

Figure 4.1 Example of select masterplan layers (Thetford Sustainable Urban Extension, Alan Baxter Ltd)



Movement

1. Constraints and opportunities analysis.

This will reveal the key spatial considerations which the masterplan should respond to (chapter 3 provides detailed guidance on this process).

2. Concept layouts and land use options.

To arrive at an agreed masterplan, it is expected that a range of different layout and land use options will be considered and tested against:

- Planning policy requirements
- Local needs and stakeholder objectives
- Commercial viability and implementation models
- Site character, opportunities and constraints
- Local context
- Development vision (see section 4.2)

Early concept masterplans and design options should be shared with Council Officers through pre-application engagement, so that they can contribute to the development of the design and understand how the preferred scheme has been arrived at.

The Council encourages the use of collaborative design workshops as a means of engaging stakeholders and the local community in the design process at an early stage. By providing an opportunity for stakeholders to help shape the masterplan, local needs and priorities can be better understood, supporting local buy-in to the scheme.



Green infrastructure

3. Masterplan refinement.

The masterplan should be refined in response to engagement and technical testing. It should, as a minimum, describe the overarching principles of:

- The proposed movement network and street hierarchy
- The green infrastructure network
- Broad arrangement of land uses, urban blocks and density assumptions
- Character areas

The masterplan should be presented as a single drawing which establishes the development framework for the site. This will be supported by a series of drawings which present different aspects /layers of the plan. Where a site is to be delivered in phases, a phasing plan will identify the structuring elements which each phase should deliver. It is also helpful if the layout principles established in the masterplan are tested by a more detailed illustrative masterplan.

CDC expects that a series of parameter plans will be included as part of an outline planning application. The requirements should be agreed with CDC planning officers during pre-application discussions, but are likely to include information on heights, density, movement network, green infrastructure, landuse and block structure.

4. Masterplan evolution.

The masterplan will continue to evolve in response to the findings of detailed design work, consultation response and surveys, and should be periodically revisited.

Chapter 4 of publication, **Creating Successful Masterplans, CABI, 2004** provides further guidance on the masterplan design process.



Density



Illustrative plan

4.2 Flexible design briefs and viability

The design brief should evolve in response to the findings of the opportunities and constraints analysis and the development of the masterplan.

The design brief is a key driver for the masterplan and sets out the client's objectives for the site alongside local planning policy requirements including any specific site policy, SPD or development briefs. Early engagement with the Council is essential to ensure that the developer's feasibility plans are in line with Council aspirations for a site. It is important that the proposed mix of uses / housing mix are appropriate to the size of development and the development's

location within the hierarchy of settlements in the district. It is appropriate that the materials palette and material uplift is considered at this stage (see chapter 7 for details of appropriate materials in different parts of the District).

It is important that the brief is not fixed too early in the design process. Flexibility is required so that opportunities and constraints which emerge through the design process can be taken on board and factored into a site's feasibility. This will enable the masterplan to respond positively to local needs, characteristics of the site and surrounding context.



The use of locally appropriate, high quality materials must be considered early on - Ashford Close, Woodstock

4.3 Vision and character

The masterplan shall be accompanied by a vision statement, describing the intended character of the development, which will inform all future design decisions.

The Council expects a character-led approach to design, where the intended character informs all design decisions including density, architectural appearance, street arrangements, landscape design and land uses.

A clear understanding of the elements of a site's character and its existing features (landscape, townscape, surroundings, history etc.) should inform the vision and provide inspiration for the design character (refer to chapter 2 for details of the analysis process). Reference should also be made to chapter 2 to identify the Countryside Character Area within which the site falls and the appropriate design response. The Council will expect to see a palette of local materials, or a highly sustainable approach, used across the plan and this should be included for within early viability appraisals. The vision statement should consider how within the palette, variation can be used to reinforce different character areas of the plan including key public spaces and frontages.

The intended character shall be communicated in a vision statement at an early stage of the masterplanning process. The vision should avoid generic statements, using words and images to provide a strong visual picture of the development's character, form and function i.e. what it will look like, what it will feel like and how it will function.

The vision shall be discussed and agreed with the Council at an early stage. This is important in establishing consensus on the development approach. The vision should be used as a point of reference which flows through the design process at all scales. Generic statements should be avoided.

On larger sites it is appropriate to identify localised character areas which reflect proposed differences in street and land use characteristics and the role of different places within the scheme as part of the overall settlement.

The eventual development character of a place will be composed of many elements, including: building form and style, materials, trees and green spaces, land uses, views, topography and climate.



Figure 4.2 Example of a vision summary, for Loftus Garden Village, Newport, Wales, Alan Baxter Ltd.

Elements of character

Enclosure or openness

In many parts of the District the enclosure of streets and spaces by the scale and continuity of built form is an important feature. Detached high status buildings are less frequent and generally set back in a larger plot. Front gardens bounded by hedges, stone walls and/or railings are also important features which help enclose the public realm. High Street, Islip and High Street, Deddington are good examples of streets with a strong sense of enclosure.

In other areas, such as Duns Tew the main street has a wider, more open character, with a greater proportion of detached houses, informally arranged and often set back behind front gardens. Views out to the countryside, front walls, and landmark buildings at right angles to the street give a distinctive character and define the public/private boundary.



High Street, Deddington (enclosed character)



Main Street, Duns Tew (more open character)

Formality or informality

Formal layouts generally reflect a planned development rather than incremental growth. Various factors contribute to a sense of formality, including, repetition of building forms and plot widths, consistent building line, details and materials.

Queen's Road Banbury is an example. Here the formal arrangement of the Victorian grid system is evident, with long, straight streets and continuous building lines either at the back of the pavement or behind small front gardens.

In contrast, historic village streets generally have an informal, organic character with each building unique and built plot by plot. The alignment and width of the streets fluctuates in response to local site conditions and movement desire lines.

The North Side in Steeple Aston and Little Bridge Road in Bloxham are good examples.



Queen's Road, Banbury (formal arrangement)



Little Bridge Road, Bloxham (informal arrangement)

The importance of landscape and trees

Green spaces and squares are important elements in many of the District's settlements. Village greens and grassed verges with mature trees provide character and an important community focus as well as ecological benefits.

A regular arrangement of street trees lend a more formal character to the grander nineteenth and twentieth century streets with the addition of hedged front boundaries in the later garden suburbs. At Lower Heyford the settlement naturally gravitates towards informal square around which the church, the village pub (and historically the school) are clustered. An impressive mature oak tree forms a centrepiece to the space.



Lower Heyford



Private garden, Bloxham

4.4 Land use mix

The land use mix should reflect local needs, promote a variety of house types and tenures and integrate appropriate non-residential uses.

Housing mix

It is expected that homes in a range of sizes and typologies will be accommodated within development and arranged in a manner which reinforces the proposed character of different areas within the masterplan (see section 4.3) and reinforces the character of the settlement and the District.

The mix of property sizes should be driven by local needs set out within the Local Plan and should provide for all ages / lifestyles. The mix should be discussed with the Council at an early stage.

Non-residential uses

Non-residential uses are important to bring activity to the settlement at different times of the day. They provide opportunities for social interaction and employment, and by locating them within walking distance of residents, reduce the need to travel. They also help integrate the new development into the existing community.

The location of non-residential uses should be considered in response to the proposed character and structure of the masterplan, but also in relation to the structure of the surrounding area and existing uses (schools, shops and local centres).

Grouping uses as part of a local centre, within a ten minute walk (approximately 800m radius) of a large catchment of residents and on public transport routes will provide a heart and central focus to a plan. Local centres should contain a mix of employment, retail and community uses of a suitable scale to meet the needs of local residents, with homes or offices occupying upper storeys.

Non-residential uses are not restricted to local centres or employment zones and can be integrated into residential areas to bring vitality.

Non-residential uses include:

- Live/work facilities or support for home-workers
- Business units
- Cafe / pub or restaurant
- Crèche or school
- Sports facilities
- Healthcare
- Shop
- Library
- Community meeting place
- Place of worship



Development at Fairford Leys, Aylesbury, has provided a mix of commercial and community uses (image source: John Simpson Architects)

4.5 Masterplan block and street structure

The masterplan must be based on a connected, permeable layout of streets defining urban blocks and open spaces.

A masterplan's basic framework is comprised of streets, urban blocks and green infrastructure. All elements should be considered together to create a layout which responds to the findings of the site analysis process and local settlement patterns (see chapter 3).

The masterplan layout is fundamental to the eventual character of the development and should be developed alongside the vision. The masterplan defines the key spaces and places and the sequence in which they are experienced. Its street structure may be formal or informal and the urban block shape and size will influence the choice of building typology, garden and car parking arrangements.

Street network considerations:

- The masterplan should establish a street, cycle and footpath network which connects into existing routes to the surrounding settlement and countryside. It should consider future desire lines between different places within the plan and the wider area
- The masterplan should make it easy and attractive to walk, cycle and use public transport across the development, establishing a well connected network of streets to create a 'permeable' settlement with direct walking routes in all directions
- Cul-de-sac and private driveways serving multiple dwellings should be limited
- Different types of streets will make up the network, to form a hierarchy that reflects variations in placemaking and movement functions and aids legibility (see chapter 5 for further details)
- Local centres should be located on main routes and at junctions where they are easy to find, benefit from passing trade and can be served by public transport
- The layout of the street network should positively respond to the street pattern and layout of the local area unless adjacent area dominated by inappropriate cul-de-sac development
- The arrangement of streets should incorporate traffic calming within the design to minimise the need for formal traffic calming measures

- Streets will normally have a simple geometry and avoid a winding form unless dictated by local conditions
- Car parking numbers and arrangements should be considered at an early stage, especially in relation to how on-street parking can be successfully integrated without compromising the public realm

Chapter 5 provides further details on how the character of individual street types should be defined, and how vehicle movement can be accommodated without detriment to character and pedestrian / cycling priority. It also sets out the range of parking solutions which can be applied to different parts of the development.



Figure 4.3 Inappropriate dispersed, cul-de-sac and car-dependent layout (top) versus traditional, connected, walkable layout (bottom). Both examples from Banbury

4

Block structure considerations:

- The size of a block structure is defined by the street network and can vary, depending on the proposed uses, plot and building typologies and site conditions such as topography or landscape features
- The arrangement of blocks may take a formal or informal grid form, reflecting the existing settlement pattern and vision for the development
- The Urban Design Compendium (section 3.7.2) recommends block widths of between 80-90m reducing to 60-80m in town centres to provide flexibility for a range of different uses and typologies
- The blocks should assume a perimeter block arrangement (see section 6.3) creating a clear definition between the public realm of the street and the private realm of the blocks
- The block structure should consider where landmarks including buildings and public spaces should be located to create a memorable sequence of places and spaces
- The arrangement of the block structure should consider orientation and micro-climate in response to sustainability objectives (see section 4.9)

Reference should be made to the Urban Design Compendium chapter 3 for detailed guidance on masterplan street and block arrangements.

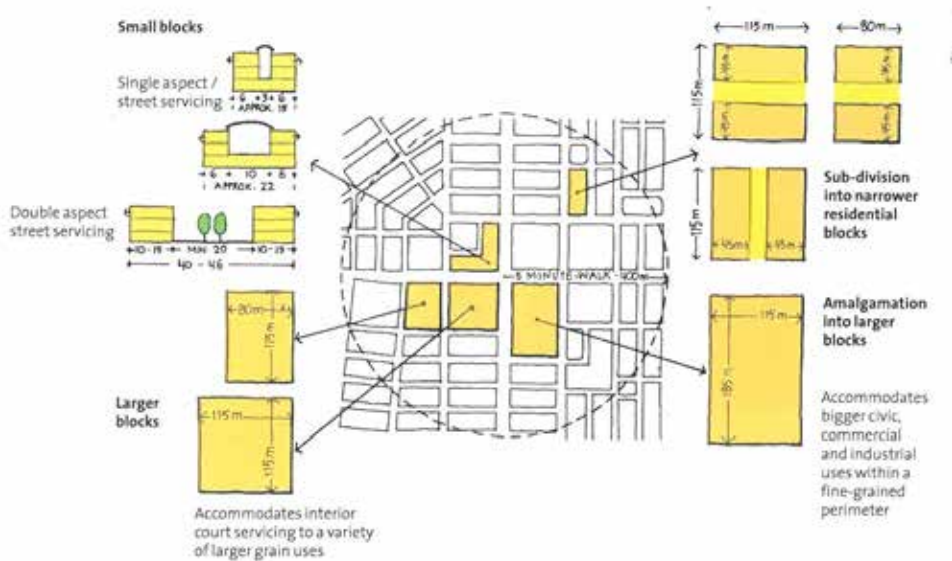

Figure 4.4 Mixed use neighbourhoods should contain a range of block sizes to promote variety (source: Urban Design Compendium p 65, adapted from Baulch, 1993)

4.6 Relationship to the existing settlement

Where development is located within or at the edge of an existing settlement, the site layout should read as a natural evolution of the settlement, have a positive relationship with the existing settlement edge and allow for future expansion.

The historic evolution of the settlement and the characteristics of the site edges should be understood as part of the site analysis process so that the masterplan structure can create appropriate visual and physical connections between new and old.

The following aspects should be considered:

Settlement pattern

New development should follow the historic pattern of settlement growth in the local area and read as a natural continuation of the settlement's evolution.

For example:

Historic growth along movement routes is evident in linear settlements, with homes fronting the street. This arrangement should be replicated in new development with new homes fronting the street.

The highway character of the street may need to be adjusted in response. For example, speed limits should be reduced to enable multiple access points. Settlement gateway features should be relocated to the edge of the development.

The development of individual sites as discrete housing estates, off a single main access with little lateral connectivity into the surrounding street network is to be avoided. It fails to reflect historic patterns of settlement growth, reduces the potential for community interaction and creates disconnected places with increased reliance on the car.

Connecting old and new

The proposed movement network within the site should connect into the existing network of streets and footpaths in the wider settlement and countryside. The alignment of historic routes (footpaths, lanes) within the proposed street network should be retained.

The masterplan layout should also consider potential expansion of the settlement in the future in a connected manner. The developer should provide evidence as to how this criteria can be met.

Figure 4.5 Positive settlement evolution

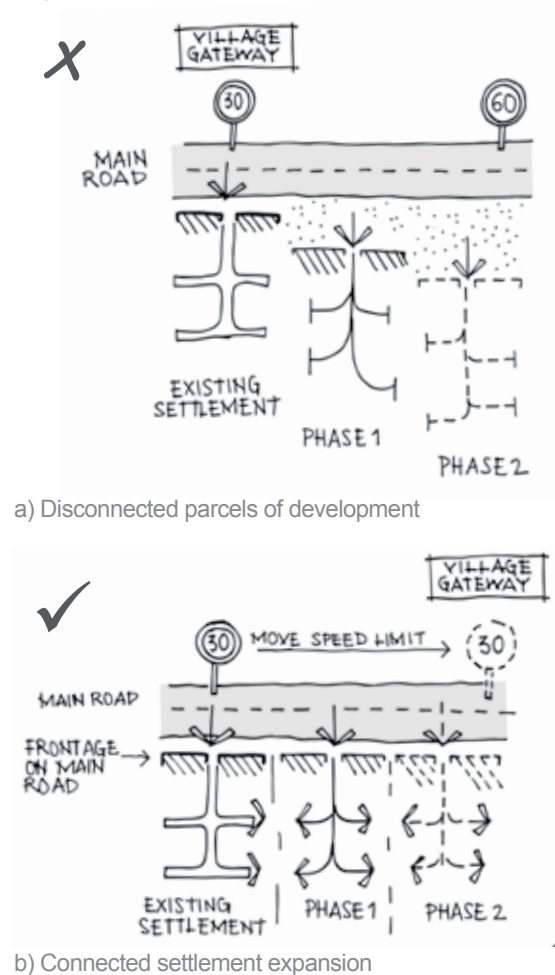

Settlement patterns of the District

Broadly speaking, there are three main settlement patterns seen across the District:

Linear settlements developed primarily along a through-route with smaller side streets branching off and are common across the District. The built form may originally be only one house deep on each side, developed gradually plot by plot. More recent development can be incongruous with the linear form, either filling in backlands or creating a small estate branching off the main road with limited frontage to the street. Examples within the District include Hethe and Bloxham.

Nucleated settlements are more compact in form and typically developed around a junction, church or manor house. They often exhibit higher densities

at the centre, dispersing towards the periphery. Wardington, Deddington and Shennington are examples of nucleated settlements, although Wardington is, in fact, bi-nucleated since it evolved from two settlements based primarily around the church and medieval manor house respectively, joining together to form one village in the twentieth century.

Dispersed settlements often have a large open space at centre, in some instances due to topography or a watercourse, or as a result of development clustering around different manors in close proximity. Fringford is an example where a large open space is located on the Main Street, whereas Steeple Aston is dispersed due to the settlement being situated either side of a small steep valley formed by a tributary of the River Cherwell.

Figure 4.6 Settlement figure ground diagrams:
Linear settlement - Hethe

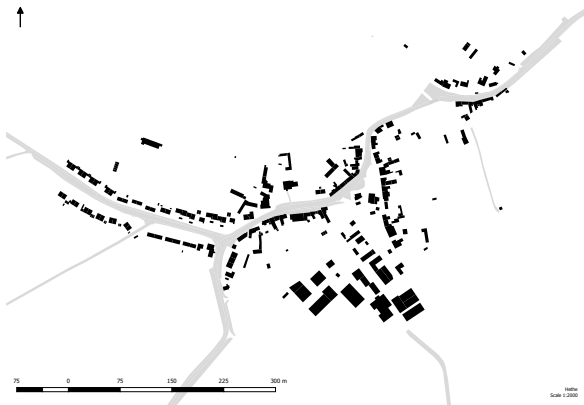

Nucleated settlement - Shennington



20th century estates altered the settlement pattern (highlighted in yellow) - Bloxham



Dispersed settlement - Steeple Aston

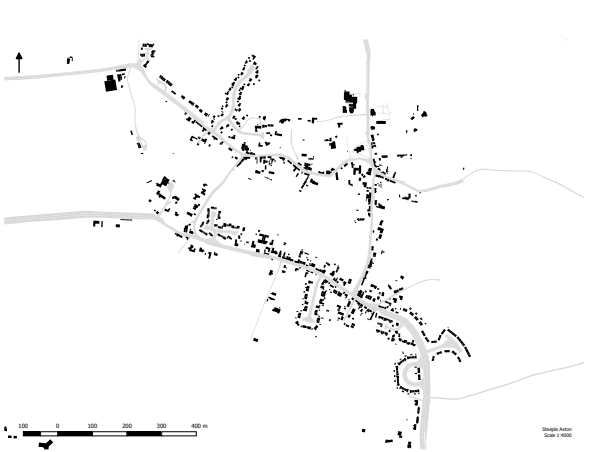

Relationship to landscape and ecological structures

The masterplan structure must consider how existing ecological features within and adjacent to the site such as woods, hedgerows, ponds and watercourses can be protected, integrated and enhanced as part of the proposals.

Consideration must be given to their role within the ecological framework of an area and also their recreational value.

A clearly defined green infrastructure strategy is required as part of a masterplan, which considers how the existing structure can be reinforced and enhanced through SuDS and additional open space features both within and adjacent to the site (see figure 4.8).

Relationship to the topography

The extent of development and the layout of streets should reflect the unique relationship between a settlement and its topography.

For example:

A settlement should not breach the apex of a hill where it is contained within a basin or valley.

Settlements located on valley side and hill tops should use the topography to create striking views and scenic lanes that follow the contours.

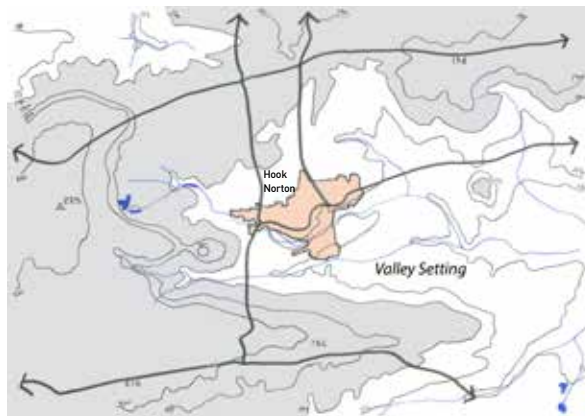

Figure 4.8 Hook Norton - topography has influenced the extent of settlement

Edge relationships

The masterplan street and block structure should positively address the existing built edge of the settlement.

For example:

- Where backs of properties make up the edge of the existing settlement, new development should back onto this to secure the backs and complete the perimeter block
- Where the edge comprises buildings fronting onto a street or green space then new development should either complete the other side of the street with new frontage or be set back behind a public open space accessible by both existing and new.

Figure 4.7 Positive edge relationships

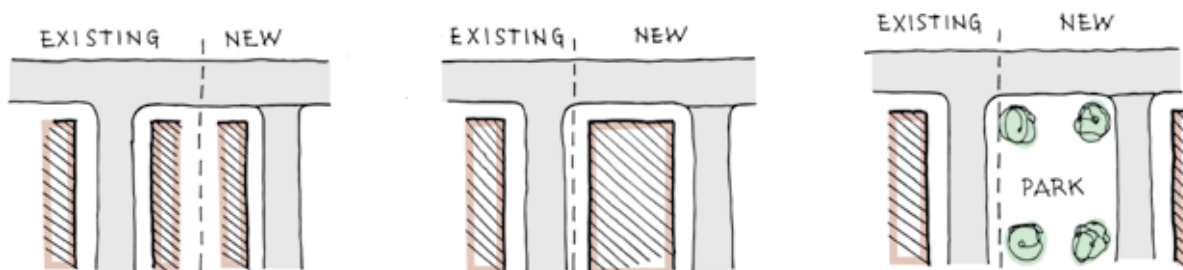

a) existing settlement edge of back gardens - new development encloses with new back gardens, creating security

b) existing settlement edge of frontage onto a road - new development completes the street with frontage on the other side of the road, creating enclosure

c) existing settlement edge of frontage onto a road - a park is created so the new development does not impose on the existing settlement and preserves mature trees

4

Creating a new edge

The masterplan should establish a positive built edge to the development, using built form and planting to frame views into the development rather than to screen it.

Development should not be hidden behind hedges, especially on key routes. It is appreciated that in some sensitive locations a strongly planted edge will be appropriate in response to local character.

The masterplan character areas should consider the appropriate scale and form of the edge, whether it is to be open and low density, merging with the landscape or a crisp urban edge for example. This should be reflected in assumptions about density and urban form. Figure 4.9 illustrates how the image of the settlement can be positively managed.

Wider views

The layout of the masterplan should consider how the settlement will be viewed from the wider landscape. Significant views into the existing settlement, such as to a church steeple, should be preserved and enhanced by the new development and new views to gateways and landmarks established.

Figure 4.9 Creating a positive edge
(source: Essex Design Guide, Essex County Council)

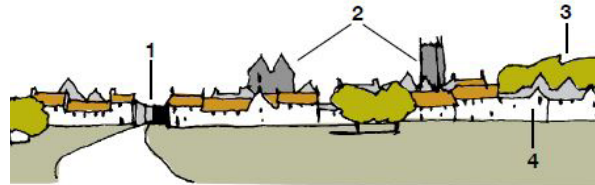

External Image

1. Clear entrance
2. Key buildings
3. Block of trees
4. Well defined urban edge

Figure 4.10 Integrating important views



The view to a church becomes framed by built frontage

4.7 Landscape structure

Existing landscape features should be incorporated positively and reflected in a green infrastructure strategy for the development.

Existing features of the landscape (e.g. hedgerows, tree belts, single large trees, watercourses and ponds, topographical features and habitat areas), should be used to create a structuring framework for the masterplan and will bring a sense of maturity to the development from day one. Often these elements have historic significance and form part of a larger ecological framework. Habitats for wildlife should be retained and enhanced as part of the development proposal.

An overall green and blue infrastructure plan should be produced identifying the proposed network and hierarchy of open spaces. These should be designed to be multi-functional, offering a range of benefits for example: habitat, movement, drainage, sports, informal recreation and food growing. These spaces should be linked to form a network of routes for wildlife and people. The features should be fully integrated, connecting new, proposed and existing habitats and public open space on and beyond the site. This should be informed by a tree and hedgerow survey and phase 1 habitat assessment.



An avenue of tree and low hedges along Whitelands Way, South West Bicester is in keeping with the formal character of the street

Open space standards

The amount, type and form of open space, sports and recreation provision within the masterplan will be determined having regard to the nature and size of development proposed and the community needs likely to be generated by it in accordance with Policies BSC 10, BSC 11 and BSC 12 of the Cherwell District Local Plan. This will be agreed with the Council as part of the land use mix together with secure arrangements for its management and maintenance.

Detailed guidance on the implementation of these policies is set out in the Council's Planning Obligations emerging SPD. The Council's Recreation SPG, 2004 (currently under review) provides best practice policy on green infrastructure, landscape and play, including guidance on the design, type and number of playspaces.



Children's play incorporated into a central green space, Clay Farm, Cambridge

Hedgerows

Hedgerows and hedgerow trees provide linear wildlife corridors which where possible should be retained uninterrupted and located in areas of public ownership where they can be protected and maintained.

Where linear green corridors are created following a retained hedgerow, the corridor should be wide enough to accommodate other functions such as public open space, drainage, footpaths and cycleways.

The integration of hedgerows within the urban environment should be carefully considered at the masterplan stage, recognising that the ecological benefits of retention may not always outweigh the placemaking benefits of their selective removal (for example to enable a permeable street network).

Where hedgerows separate proposed development from an existing street network, limiting the integration of the scheme, the hedgerow should be removed and additional planting provided elsewhere.

Figure 4.11 Sketch options for incorporation of an existing hedgerow into the urban fabric

a) Hedge forms side boundary of lane

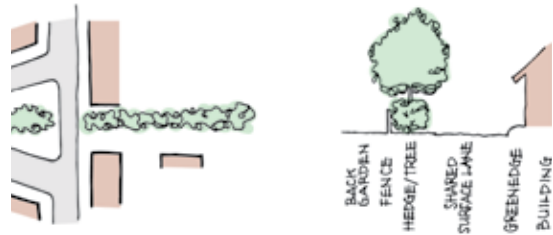

b) Hedge incorporated into park

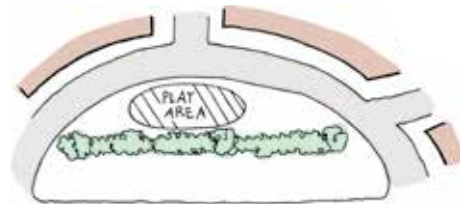

c) Hedge incorporated in wide green/cycle corridor

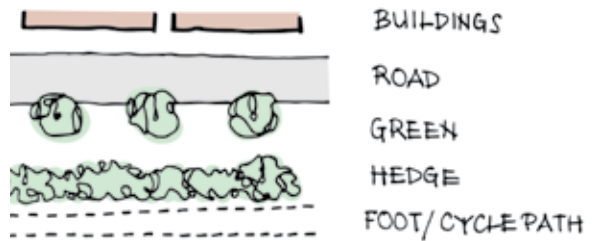

Existing hedgerow and mature trees are retained to form a landscaped edge to a new development, Lower Heyford

Sustainable Drainage Systems (SuDS)

SuDS are a key piece of green infrastructure and should be considered as a structural element of the overall masterplan. They should be viewed as an opportunity to bring character to the development through their careful integration within both green spaces and streets.

In line with the Government’s Written Statement to Parliament on Sustainable Drainage Systems (18th December 2014, to come into effect 6th April 2015), SuDS for the management of run-off are to be put in place on major developments (over ten dwellings) unless demonstrated to be inappropriate.

A SuDS strategy should be prepared alongside the masterplan for the site as a whole with consideration of the surrounding context. It should be designed with the input of both a drainage engineer and landscape

architect. When considering the appropriate form of SuDS, the Sustainable Drainage System Train (see figure 4.12) should be followed, noting that the Council promotes open systems where possible, with swales and ponds preferred over crates. Refer also to the Cherwell Local Plan Part 1, 2015 Policy ESD 7: SuDS.

Clear arrangements are to be put in place for on-going maintenance of SuDS features over the lifetime of the development. In general, it is assumed that the developer will construct the SuDS and provide a maintenance plan and maintain for a minimum period prior to adoption by CDC. This is to be agreed with CDC in pre-planning. Detailed guidance on SuDS is contained within the Construction Industry Research and Information Association (CIRIA) publication, The SuDS Manual (C753), 2015. Case studies and further information is provided on the CIRIA website www.susdrain.org.



From left: attenuation pond, South West Bicester; swale, Trumpington Meadows, Cambridge; dry detention basin within parkland, Clay Farm, Cambridge.

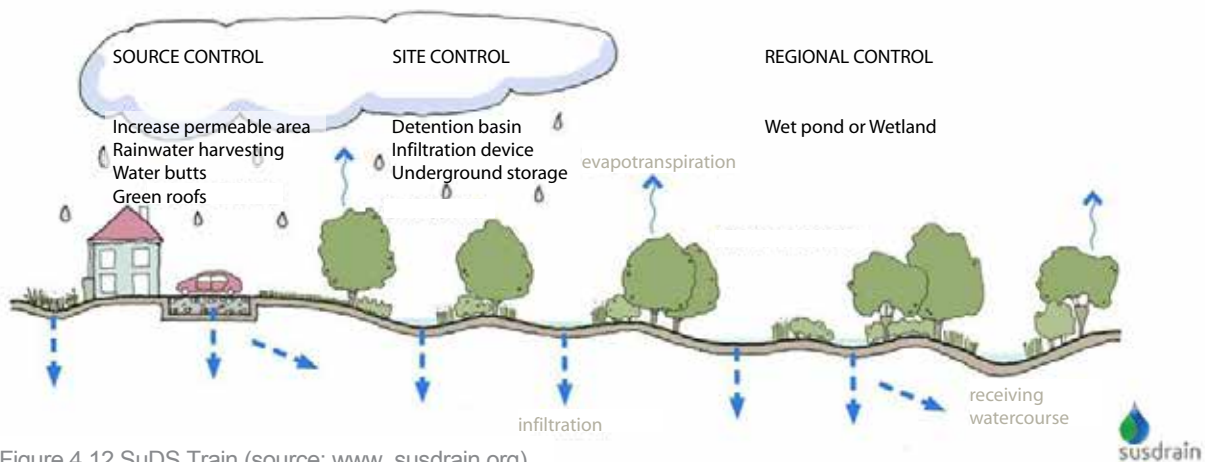

Figure 4.12 SuDS Train (source: www.susdrain.org)

4.8 Density

Density should vary across larger sites reflecting proposed variations in character, landuse and function.

Measurements of density are a useful tool to test the development capacity of a site during the early stages of the design process. However this should also be considered with the building form, typology and plot ratio. There are a number of methods for calculating development density. In Cherwell, net density should be used for planning purposes which is calculated using the former PPS3 definition i.e.

$$\frac{\text{Number of homes}}{\text{Area of residential development and associated uses (hectares)}} = \text{net density (dwellings per hectare (dph))}$$

For the full definition see **Appendix E**.

Character and density

Masterplan density assumptions should be set in response to the proposed character, landuse and role of different areas. They should reinforce the hierarchy of places within the settlement with higher density areas located around settlement centres and main streets, where residents can readily access and support local shops, services, jobs and public transport. However, the highest densities may be at the edge of the development if this is closest to an existing local centre.

Density is not in itself a reliable indicator of character. In general, density increases as plot size decreases, however there are a number of other factors which affect density and character:

- Building typology and arrangement
- Garden size
- Street widths and public realm design
- Car parking provision and arrangement
- Site conditions such as topography and development constraints
- Non-residential uses within residential areas
- The efficiency of the layout considering all of the above

Building typologies should be appropriate to plot sizes. As a result the proportion of detached and semi-detached homes will reduce as the density increases to avoid the appearance of town cramming and to ensure larger properties have appropriate amenity space (see figure 4.13).

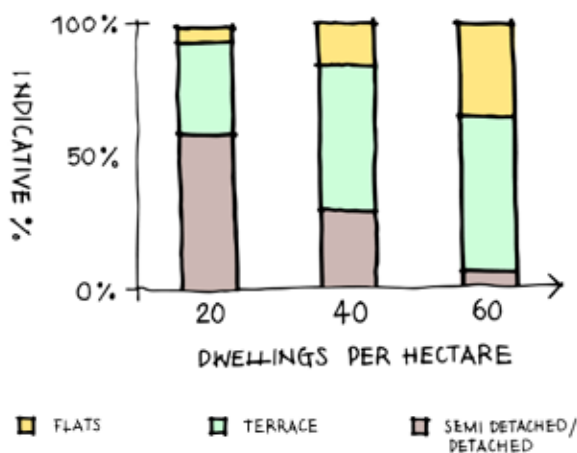

Figure 4.13 Indicative split of house typologies at different densities



Similar density...



...but very different character

Through careful design, inefficiencies in the layout can be reduced to increase densities without loss of usable space and with a positive impact on townscape.

Areas where efficiency can be increased include:

- Reducing the amount of space occupied by highways (see section 5.5)
- Using a terrace form rather than small detached or semi-detached typologies
- Bespoke house types which can make best use of awkward plots
- Reducing the amount of allocated car parking (see section 5.8)
- Designing out 'leftover spaces' in the public realm

The masterplan density assumptions should be tested using character area design studies, and subsequently adjusted as the site layout is developed in detail.

Chapter 6 provides further guidance on appropriate building typologies.

Minimum density standard

To ensure that land across the district is used in an economical manner, Policy BSC 2 of the Local Plan Part 1 requires that new housing should be provided on net developable areas at a density of at least 30 dwellings per hectare (dph) unless there are justifiable planning reasons for lower density development.

The policy is not intended to limit urban design thinking or imply a blanket character or building typology.

The Local Plan density requirement is a minimum and should be calculated as an average across the site as a whole. The Council expects to see considerable variation in densities across larger sites.

In town centre locations and around transport hubs, densities of 50 – 80 dph may be appropriate. Mid level densities of 30 – 40 dph would be expected on most strategic sites, allowing a significant reduction in development intensity in more sensitive areas.

Figure 4.14 Designing out inefficiencies

Typical inefficient estate layout with poor street enclosure and unnecessarily wide junction

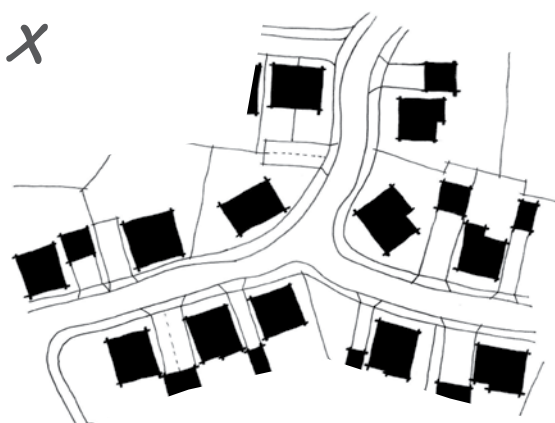

Improved street frontage and tighter junction design, delivers four extra homes

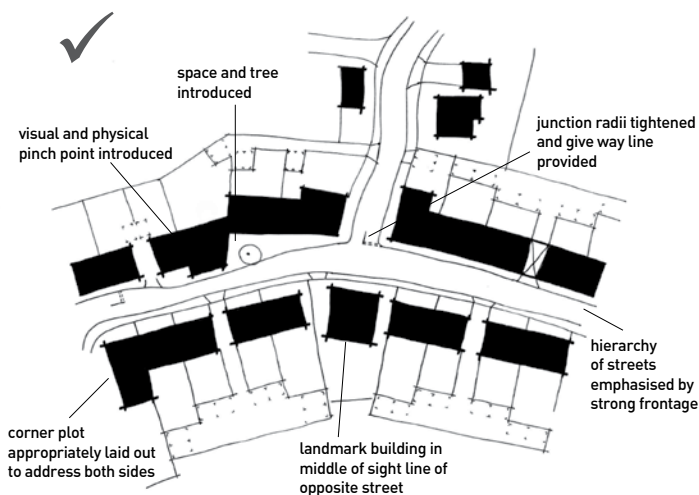

4.9 Sustainability considerations

CDC will expect to see evidence that sustainability considerations have been taken into account in the design of the masterplan.

The masterplan layout has a significant impact on sustainability. This is explored in chapter 8. In summary:

- A connected, permeable layout, with a mix of uses within walking distance, will reduce the need for residents to use their cars, in turn reducing fuel consumption, improving air quality and the health and wellbeing of residents
- Higher density areas including local centres have greater potential for energy efficient district heating systems
- Terrace homes and apartments are inherently more energy efficient than detached homes.
- SuDS features and green infrastructure such as green roofs and habitat corridors need space and should be planned for at an early stage. (See section 4.7)
- The alignment of streets and urban blocks and their relationship to site topography set the parameters for building orientation. This affects the potential for natural daylighting and passive solar gain (reducing the need to artificially light and heat houses respectively). Orienting buildings broadly to the south optimises the solar potential of the site including the potential for photovoltaic panels, tending to result in an east-west street pattern. Staying within 15-20 degrees of due south maximises the potential for light and solar gain, although it is possible to move away from this and still capture a sufficient amount.
- The spacing of buildings and orientation of streets and public spaces must also be considered in relation to the wind. Wind can be a positive natural ventilator but buildings which are spaced too far apart or are much taller than their surroundings increase gusts and funnelling, and create eddies and vortices. This creates uncomfortable public spaces and results in building heat loss. By considering landscape and urban form together any potential climatic issues can be mitigated through appropriate planting creating shelter from the sun or wind
- The location of public spaces should also consider solar effects – whether a space will be too overshadowed for public use or a suntrap.

ESD 1-7 of the Cherwell Local Plan sets out the Council's policies for sustainable development.

The BRE guide 'Site layout planning for Daylight and Sunlight: a guide to good practice, BRE, Sept 2011' provides further guidance on this subject.

Sustainable Exemplars

In all developments, opportunities to incorporate sustainable technologies and raise levels of energy efficiency should be taken wherever this can be successfully achieved without detriment to the urban form and placemaking objectives of the vision.

Where the vision is for a sustainable exemplar with high levels of energy efficiency, it is recognised that this will have an influence on the urban form of the masterplan and the design of individual buildings. Chapter 8 provides further information on these approaches.

Figure 4.15 Sustainable design working with the sun (source: Urban Design Compendium, p50)

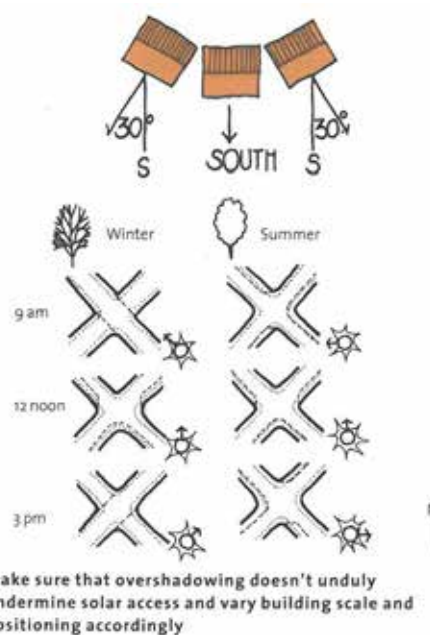

5 STREETS AND SPACES



- 5.1 The importance of the street
- 5.2 Street character
- 5.3 Street proportions
- 5.4 Design for pedestrians and cyclists
- 5.5 Design Criteria for vehicles
- 5.6 Design for buses
- 5.7 Integrated traffic calming
- 5.8 Car parking
- 5.9 Avenue trees, planting, SuDS and landscape
- 5.10 Public spaces
- 5.11 Street materials
- 5.12 Utilities corridors, lighting and signs
- 5.13 Waste management

This chapter focuses on the design of the streets and spaces which make up the public realm. It explains how placemaking considerations should be prioritised over vehicle movements to encourage walking, cycling and human interaction. Guidance is provided on street types and dimensions, car parking, public transport and cycling infrastructure, utilities and landscape.

It should be read in conjunction with chapter 4 which explains how a connected, legible network of streets is established in the masterplan, and chapter 6 on the arrangement of buildings to successfully enclose and frame the street.

New development in Cherwell should promote:

- A connected and legible network of streets
- Street design responsive to hierarchy, character and location
- A movement network and street design which encourages walking and cycling over vehicle movements
- Design of the street in three dimensions creating a comfortable sense of enclosure by buildings
- Traffic calming integrated as part of the street layout and urban form
- Integrated design of all elements within the street including parking, bins, utilities, SuDS, trees and signage

New development should avoid:

- Lack of hierarchy and distinctiveness across the street network
- Disconnected, indirect, impermeable or illegible routes
- Design and consideration of streets in plan form only
- Poorly considered parking arrangements
- Over use of private routes serving multiple properties, limiting connectivity of the site
- Lack of consideration of trees, SuDS and utilities at an early stage of design
- A traffic calming strategy of artificial, regular bends without placemaking rationale
- Over-engineered street design

Please refer to the following chapters for supporting information:

- **Chapter 2:** For a summary of District's distinctive characteristics and character areas
- **Chapter 3:** For details of how site analysis should be undertaken to inform the masterplan
- **Chapter 4:** For details of the how the street network and hierarchy is established in the masterplan and Vision Statement
- **Chapters 6-7:** For guidance on detailed design relating to the private realm, including building and plot arrangements framing the street and building elevations
- **Chapter 8:** For guidance on sustainability considerations

Further reading:

- **Manual for Streets, 2007, DfT/DCLG:** Detailed guidance on street design criteria for pedestrians, cyclists, public transport and motor vehicles. Guidance on parking solutions
- **Residential Road Design Guide, 2003 Second Edition 2015, OCC:** Detailed guidance on the design of streets and parking areas applicable to Oxford County
- **Car Parking, What Works Where, 2006, English Partnerships:** Review of a large number of alternative parking solutions explored through UK case studies
- **The SuDS Manual (C753), 2015, CIRIA www.susdrain.org:** Detailed guidance relating to the design of sustainable drainage systems
- **BS 5837: 2012, Trees in relation to design, demolition and construction, 2012, BSI**
- **Trees in Hard Landscapes: A Guide for Delivery, 2014, Trees & Design Action Group**
- **BS 5906:2005, Waste management in buildings. Code of practice, 2005, BSI**
- **Parking: Demand and Provision in Private Sector Housing Developments, 1996, J Noble and M Jenks**
- **The Residential Car Parking Research, 2007, DCLG**

5.1 The importance of the street

Streets make up the greater part of the public realm, are the public face of a settlement and provide the stage for movement and daily life. Good street design which prioritises placemaking over vehicle movement is therefore critical to the overall success of a settlement.

CDC and OCC are actively working together to create successful streets which prioritise placemaking considerations over vehicle movements. In particular, designing streets which are safe and attractive places in which to walk and cycle, to encourage a shift away from car based travel. Considerable progress has been made which is reflected in a move away from the illegible cul-de-sac and loop road layouts of the late 20th century, but more can be done.

The placemaking-led approach to street design is explained in detail in Manual for Streets, (MfS), DfT 2007 which should be read alongside this Guide. MfS defines streets as:

A highway that has important public realm functions beyond the movement of traffic. Most critically streets should have a sense of place, which is mainly realised through local distinctiveness and sensitivity in design. They also provide direct access to the buildings and spaces that line them. Most highways in built-up areas can therefore be considered as streets.

Successful streets

Although streets vary widely in appearance, successful streets share certain characteristics and CDC expect these to be incorporated into the design.

Successful streets:

- Are locally distinctive, responding to local characteristics rather than standard highway design
- Have a clear hierarchy and are simply organised
- Are welcoming and safe places to walk and cycle
- Are accessible and legible to all users including the mobility impaired
- Are active places which encourage human interaction
- Are framed by buildings and landscape including trees
- Form part of a well-connected network
- Have variety and interest and make wayfinding easy and intuitive
- Are a comfortable scale, with a well-proportioned relationship between street width and building heights
- Accommodate appropriate vehicle movements and car parking without these elements dominating
- Meet functional requirements e.g. servicing, utilities and property access
- Have the flexibility to adapt to changes in the future

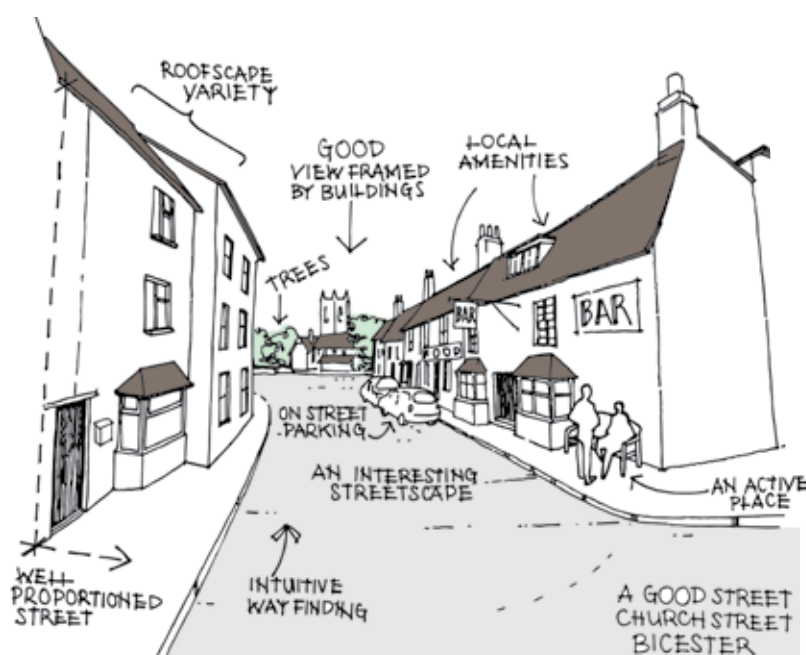

Figure 5.1 Successful streets characteristics

5.2 Street character

A character-led approach should be taken to the design of streets. Individual streets will have different characteristics reflecting their roles within the network hierarchy established in the masterplan.

The character of streets is fundamental to the character of place. There are many elements which contribute to their character which should be considered in their design:

- The dimensions of the street in cross section, defined by buildings enclosing the public realm
- The alignment of the street e.g. curving, geometric, informal or formal in its layout and its relationship to topography
- The urban form, architecture and materials of the buildings
- The trees, planting and front gardens making up the soft landscape of the street
- The hard materials of the public realm
- The surrounding land uses and spill-out activity
- Vehicle movement speed and volume
- The level of pedestrian and cycling activity
- How car parking is dealt with
- Boundary treatments

Street types

The masterplan street hierarchy should establish at a high level the character of streets across the development (see section 4.5), reflecting their roles within the overall network. Typically a larger settlement will contain a range of different street characters which fulfil different placemaking and movement functions.

The majority of streets within the settlement can be classified into the following broad character types:

- Main streets
- General residential streets
- Minor residential streets and lanes

These street types can be used as a starting point to define the specific and distinctive characteristics of individual streets, tying back to the masterplan Vision Statement.

For example:

- A formal, tree-lined main avenue, with a mix of uses on the main bus route
- A narrow, residential street with an informal character
- An informal lane at the edge of the settlement with views to the countryside



A leafy, formal avenue - Whiteland Way, South West Bicester



A shared surface street - NW Bicester



An urban mews with shared surface - Woodstock

Establishing the proposed character of individual streets early on will inform the design of all elements of street character listed above.

Figures 5.2 – 5.5 illustrate layouts for typical main, general residential and lane streets of different character. These are worked examples and are not intended necessarily to be replicated.

Main streets and high streets

Streets with high levels of activity, well connected and central, giving access to general and minor residential streets, often contain a mix of uses, accommodate public transport and local through traffic.

Figure 5.2 Indicative layout - informal main street

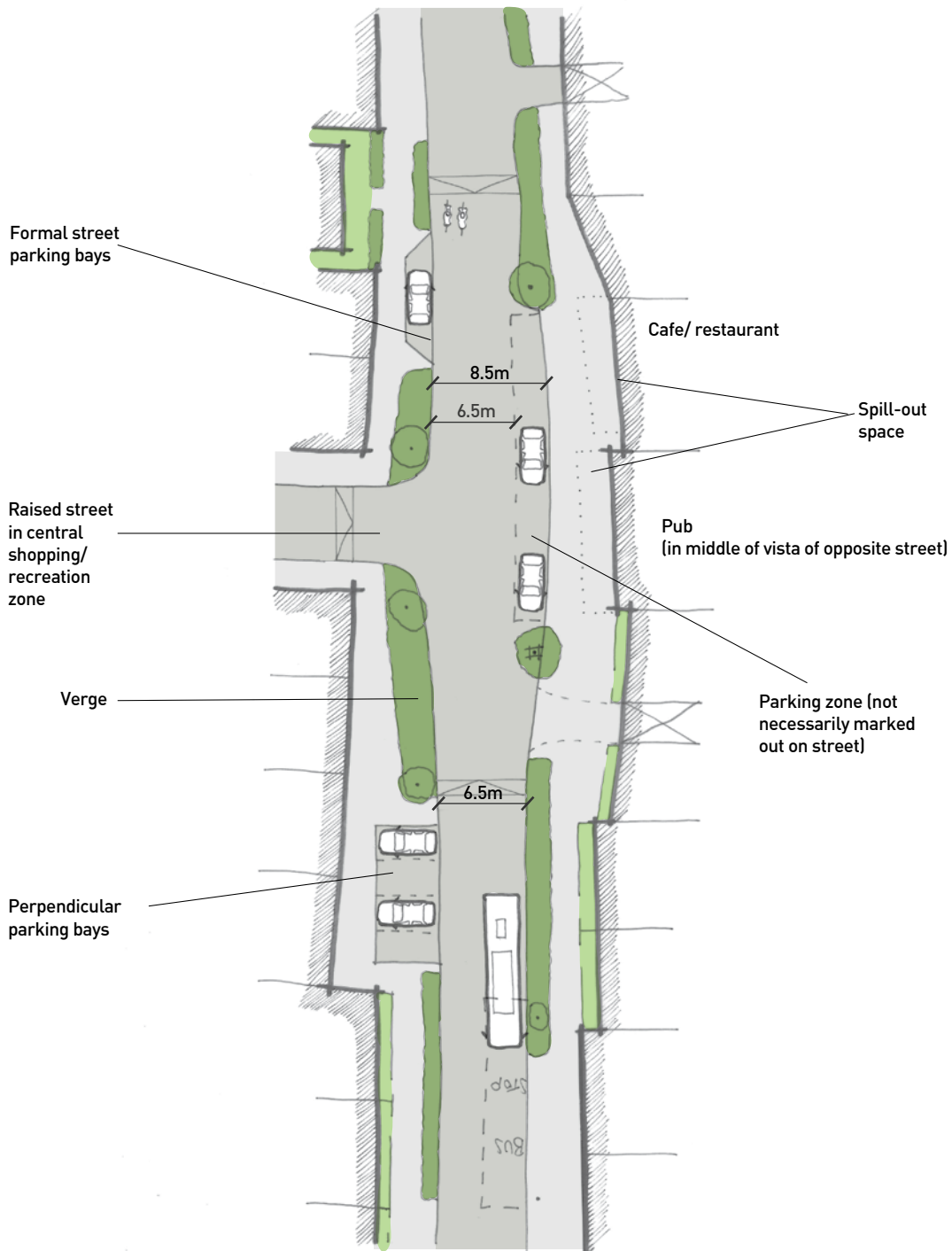
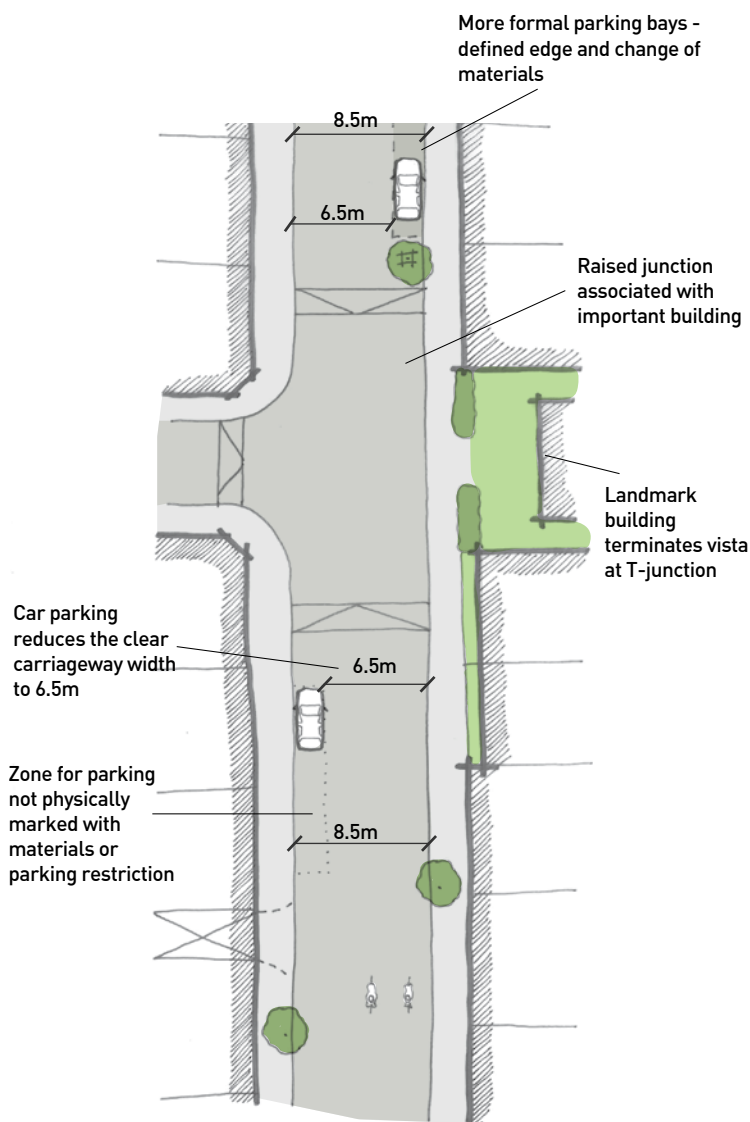

Figure 5.3 Indicative layout - formal main street



Trees and bollards demarcating parking spaces in a square, Poundbury



Tree pinch point in an informal lane, Poundbury



Street trees and bollards as traffic calming, Hook Norton

General residential streets

Predominantly residential, moderate levels of activity, neighbourly interaction, provide access to properties, some through traffic.

Figure 5.4 Indicative layout - general residential street

5

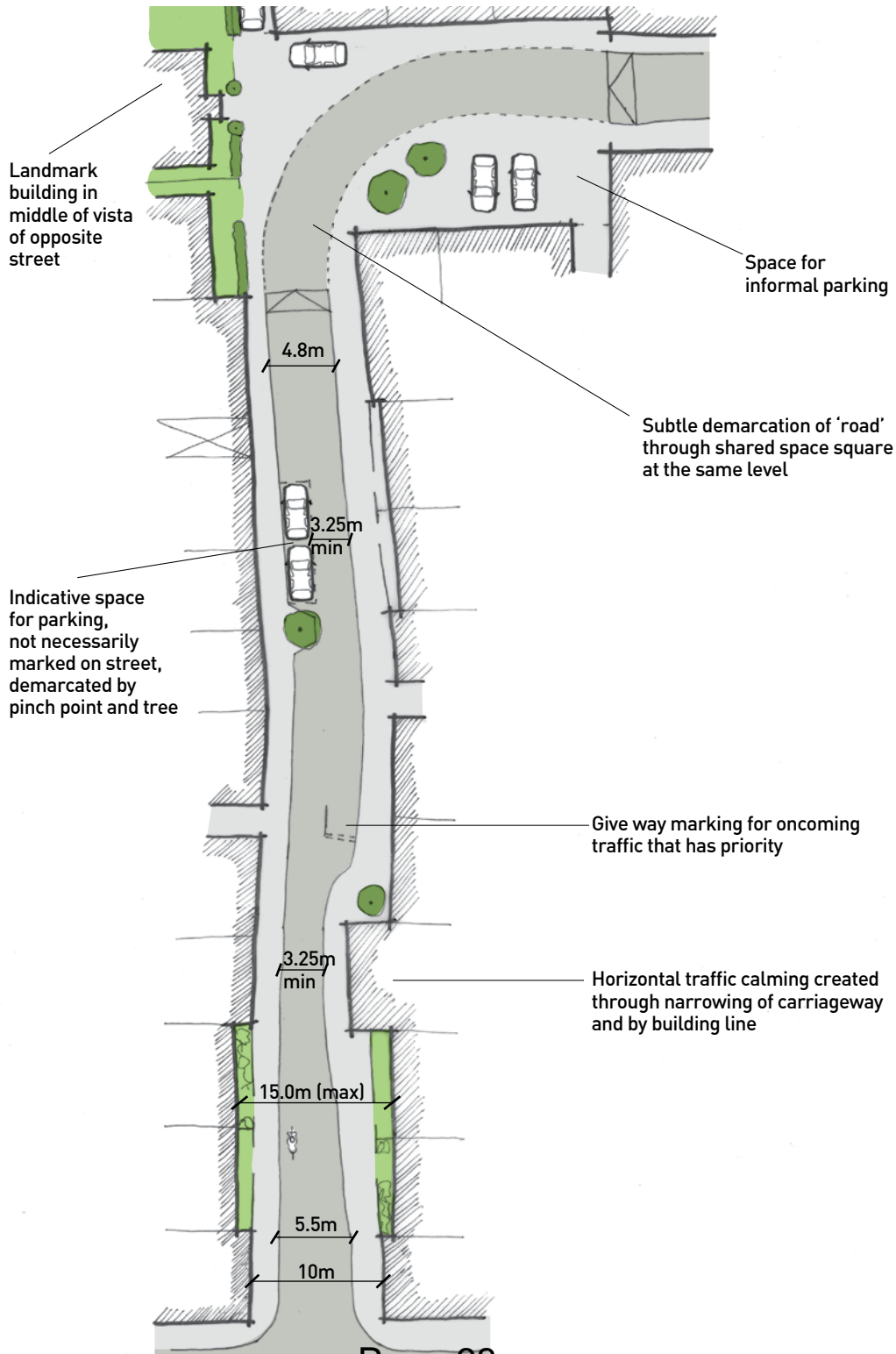

Minor residential streets and lanes

Quieter residential streets, with limited through traffic, with a semi-private feel.

Shared surfaces

The use of a shared surface approach where vehicles, pedestrians and cyclists occupy the same space within the street can create attractive, active streets successfully accommodating children's play, car parking and movement functions together.

Shared surface treatments can also be used in public spaces such as squares or at junctions where the lack

of demarcation for traffic can assist with traffic calming and placemaking functions.

The use of shared surfaces should be judicious and take into account safety of users especially those with perceptual impediments. In many areas a 25mm kerb will be appropriate, except in very lightly trafficked environments such as the lane typology, in order to aid legibility for those with visual impairments.

To achieve a successful design detailed discussions will be necessary with both CDC and OCC and appropriate safety audits undertaken.

Figure 5.5 Indicative layout - informal Lane

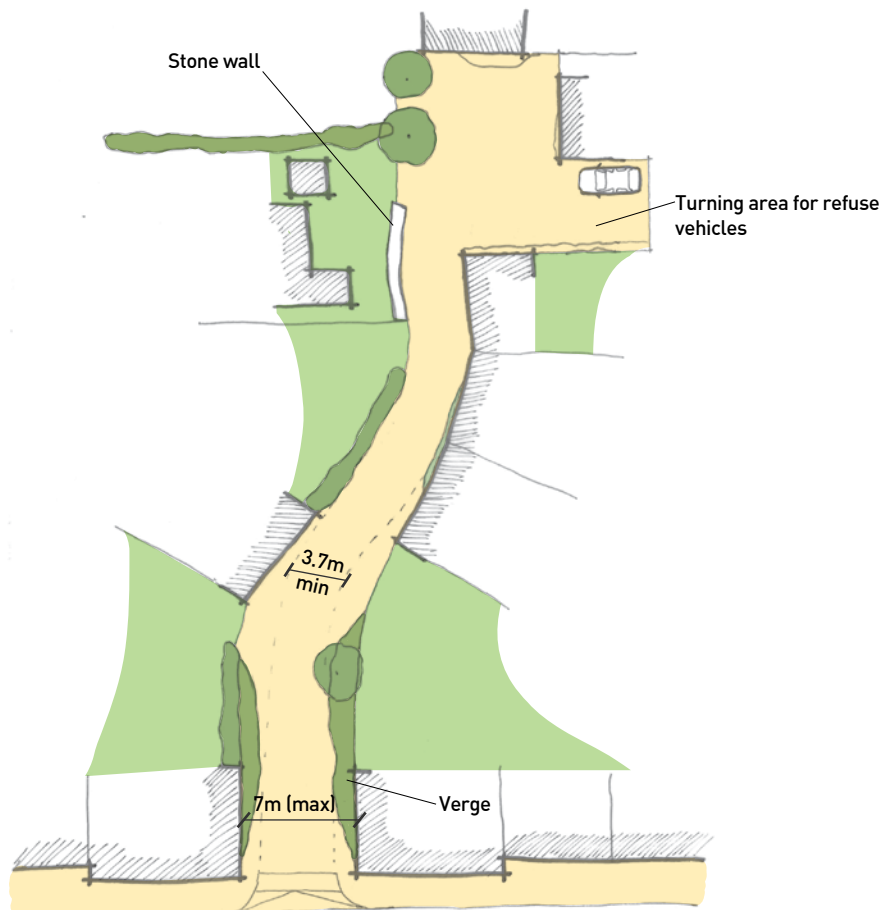

Adoption

All streets performing a public function as part of the movement network should be designed for adoption by OCC. Un-adopted, private routes serving multiple properties should be limited, except where specifically agreed with the Council.

It is important to note that design of streets needs to be coordinated with both OCC and CDC, with street types established in liaison with both authorities.

5



Enclosed street incorporating on-street car parking, Hook Norton

Figure 5.6 Indicative layout - Shared surface street

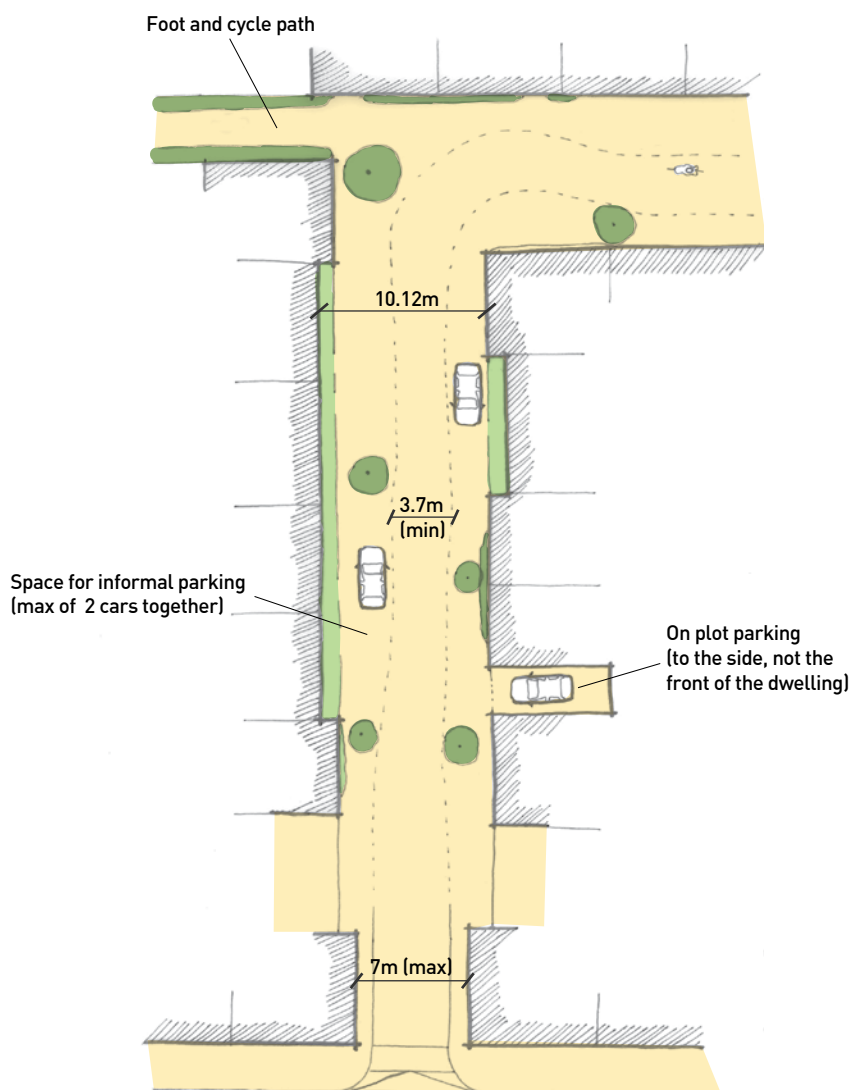

5.3 Street proportions

The overall composition of the street should create a comfortable 'human scale' and level of enclosure in keeping with the character of the District.

Buildings of an appropriate scale and form are critical in establishing well designed streets. Street cross-sections should provide a sense of enclosure through buildings, trees and planting. The Urban Design Compendium (section 5.1.3) recommends a height to width ratio for streets of between 1:1.5 and 1:3 where height is provided by buildings (generally measured to the eaves line) and width is the distance between building frontages across the street. These proportions create streets which are pleasing to the eye, feel comfortably enclosed and are not dominated by the carriageway.

Figure 5.7 Recommended height to width ratios (source: Urban Design Compendium, p88)

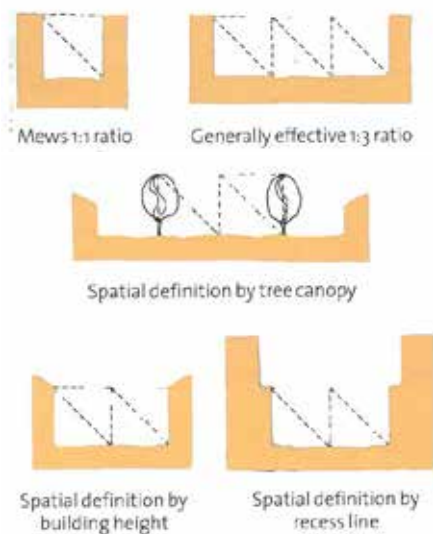

Street currently feels too wide in relation to the height of the buildings but enclosure is to be improved by the planting of street trees, Upper Heyford

This ratio range is typical of many of Cherwell's attractive historic streets, in contrast to more recent estate developments where the carriageway is wide and dominant. It follows, that where the street is wider, taller buildings are appropriate to maintain the ratio.

Although buildings are the primary means of providing enclosure, the canopy of street trees, front boundary walls and taller garden planting can also be effective particularly in maintaining the line of enclosure where there are small gaps between buildings.

The sense of enclosure breaks down where there are significant gaps in the built frontage. This is evident on streets which are comprised of multiple detached properties with parking to the side. Here the building frontage is not complete enough to properly frame the street, and the opportunity for boundary walls and trees is also limited by the need to give access to on-plot parking.

Where main streets lie on a bus route, the carriageway will need to be 6.5m wide. These streets would benefit from being framed by buildings of three storeys to balance the increased street width. Where not on a bus route, the width of the carriageway should be reduced. Parking can be formally arranged with bays broken up with street trees, build outs and informal crossing points for pedestrians.

On general residential streets, with predominantly two storey properties, the building to building widths should be reduced in comparison to main streets, to create an appropriate sense of enclosure. Increased ground floor ceiling heights can also improve the sense of scale / status of a building.



A well proportioned street, Seven Acres, Cambridge

5

Figure 5.8 Appropriate street proportions: examples from Cherwell



5.4 Design for pedestrians and cyclists

Street design should make it as easy as possible to walk and cycle, providing safe, direct and attractive routes.

Routes for pedestrians and cyclists should be safe, direct, attractive and legible. The design criteria for accommodating pedestrians and cyclists on different types of street are detailed in the Oxfordshire County Council's Residential Road Design Guide, Second Edition, 2015, MfS chapter 6 and OCC's recently approved design guidance documents on walking and cycling.

Pedestrians

Pedestrian movement must be considered first and prioritised on all streets. Walkable neighbourhoods should be established by the masterplan creating a legible and permeable street network allowing for easy access on foot to local facilities and public transport stops (see chapter 4).

Pedestrian movement should be accommodated on footways on the street giving access to property fronts. In some instances short stretches of footpath may be appropriate to provide additional pedestrian links between streets.

These should be as short as possible with good inter-visibility between the ends, appropriately lit and be overlooked / open to view.

Footways in Cherwell tend to be fairly narrow. Although the MfS recommends pedestrian footways should generally have an unobstructed minimum width of 2m, it would be in-keeping with the character of Cherwell if they were narrower.

A minimum of 1.5m width should be used which accommodates a couple walking with a buggy. This will be sufficient for general footways, however, it may be appropriate to provide a wider footway on a higher order street of 6.5m or more width; the footway should feel in proportion with the overall street width. Footways could locally widen at particular points outside more important buildings or at corners where people are more likely to stop and chat.



Humber Street, Bloxham



Main Street, North west Bicester



Pedestrian/ cycle cut-through, South West Bicester

Cyclists

In the majority of residential streets cyclists should be accommodated on the carriageways with no dedicated cycling lanes required. Uneven surfaces such as cobbles should be avoided.

On busier streets, dedicated cycle lanes should be provided on-carriageway. Completely segregated lanes are only appropriate on higher speed / volume roads. Guidance has recently been approved by OCC which will provide further advice. The design of cycle lanes and cycling infrastructure at junctions should be discussed with OCC.

Cycle parking provision is required at both ends of the journey in accordance with OCC’s Cycle Parking Standards (see below). Covered cycle parking should be provided within the curtilage of a dwelling or other convenient location for apartments. Security and convenience are two key principles for the location of cycle parking. If cycle parking is included in front gardens it should be visually attractive. If it is placed at the side or rear of a dwelling access to the street should be direct and sufficiently wide. Garages should be designed to allow space for a car and storage of bicycles and be a minimum of 6m x 3m internally.



Bus bypass in Lewes



Hybrid cycle lane, Old Shoreham Road, Bournemouth



Foot/cycle path, South West Bicester

Cycle Parking Standards		Residential
Resident		1 bed - 1 space; 2+ beds - 2 spaces
Visitor		1 stand per 2 units where more than 4 units
Notes		
1	Garages should be designed to allow space for car plus storage of cycles in line with the District Council’s design guides where appropriate (most specify 6m x 3m)	
2	1 stand = 2 spaces: The number of stands to be provided from the calculations to be rounded upwards. The preferred stand is of the ‘Sheffield’ type	
3	All cycle facilities to be secure and located in convenient positions	
4	Residential visitor parking should be provided as communal parking at convenient and appropriate locations throughout the development	

Table 5.1 Cycle Parking Standards for residential development, (extract from Residential Road Design Guide, Second Edition 2015, OCC)

5.5 Design criteria for vehicles

The design criteria for vehicle movements should be established in response to the proposed character of the street and agreed with OCC and CDC.

Design Criteria

The overall approach to street design should be to consider buildings and spaces first, with carriageways, footways and parking designed to fit within the space created. This approach enables buildings to be laid out to provide an attractive frame to the street with carriageways, kerbs and footways helping to define and emphasise spaces.

It is also important that streets are designed with consideration for the types of vehicular movements, speed and volume of traffic. The majority of residential streets should have a design speed of 20mph or less.

MfS section 7.2 provides details of minimum carriageway dimensions to accommodate different street types and functions. Careful thought is needed as to the application of these dimensions to the different street types.

Over engineering streets to accommodate easy access for HGVs and unnecessarily high design speeds leads to wide streets and large junctions which are detrimental to character and can result in an uncomfortable environment for pedestrians and cyclists. Under these circumstances it is difficult to achieve the sense of enclosure and proportion discussed in 5.3.

It is not expected that space for HGVs to pass each other will be provided along the majority of residential streets, as this will be an occasional occurrence. However, passing places should be designed in to accommodate these movements when they do occur.

Critical dimensions

The standard width for residential street carriageways is 4.8m which allows for unimpeded two way movement of cars, or a car plus HGV and this should be viewed as a critical dimension. Main streets accommodating a bus route are required to have a minimum carriageway width of 6.5m to allow unimpeded two way bus movement, though some reduction in width over a short distance, may be permissible in certain circumstances. Reference should be made to OCC's Residential Road Design Guide and MfS for further details.

As part of a traffic calming strategy designers should consider incorporating short sections of reduced width where appropriate. This supports the traffic calming approach outlined in section 5.7.

Swept path analysis and visibility

Swept path analysis is a valuable tool that should be used to determine the space required for different vehicle types as they move along or through a space.

Consideration of forward visibility through use of stopping sight analysis should also be used, particularly in relation to building lines which in themselves can be used as an integral component of traffic calming.

Section 6.8-6.12 of OCC's Residential Street Design Guide provides details of required sightlines at junctions.

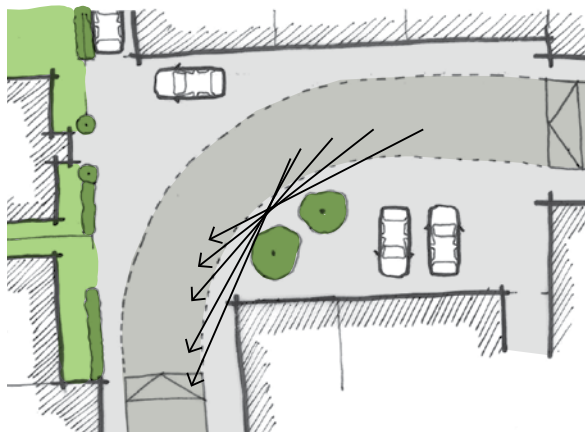

Figure 5.9 Stopping sight distance defining the geometry of the curve and placing of trees/ building lines

5.6 Design for buses

Bus routes should provide direct, convenient journeys for all new houses

All new residential development will be expected to make an appropriate contribution to the development of the countywide bus network, both through the physical infrastructure – e.g. highway measures and bus stop infrastructure – and through service provision.

(Residential Road Design Guide, OCC)

OCC requires all developments of more than 50 dwellings to be served by at least an hourly bus service and for homes to be within a 400m walkable distance of a bus stop. Appropriate provision for buses should be designed in at the outset in discussion with OCC's Public Transport Development Team.

Bus stops should be located in relation to pedestrian desire lines and close to facilities which serve a wider catchment. They should be served by safe and convenient pedestrian crossing places. Consideration should be given to proximity to domestic property and any nuisance issues in relation to the placing of bus stops.

Further advice on the siting and requirements of bus stops can be found on p73 of Manual for Streets and in OCC's residential design guide.



Bus stop, South West Bicester

5.7 Integrated traffic calming

Traffic calming should be designed as part of the street layout in a manner appropriate to the proposed character.

Traffic calming should be inherent within the street layout and can include:

- A sense of enclosure created by building lines or street tree planting which restrict forward visibility
- Changes in direction and tight corner radii
- Change in materials
- Crossing points, either raised or flush with the carriageway with build-outs/narrowings
- A change of character such as widening out into public spaces
- Frequent side road junctions and direct access points to properties

Horizontal and vertical deflection features to reduce speed of vehicles should be designed to read as inherent elements of the street rather than a piece of highways infrastructure e.g. a raised table forms part of a public square or the setting to an important building, a build-out is associated with tree planting or a crossing point.

Informal streets

Variation in carriageway width, footway width and building line is characteristic of traditional informal streets across the District. This creates streets with visual interest, but also enables parking, servicing, small areas of green and trees to be accommodated while maintaining a strong sense of enclosure and appropriate height to width ratio.

These faceted streets have a natural traffic calming effect, as drivers intuitively slow down on the approach to pinch points and junctions or where the street widens into a public space.

Formal streets

Formal streets, although generally more regular in width than informal streets, can accommodate pinch points at street entrances and widening related to public squares or gardens. The regular junctions of a grid layout have a natural traffic calming effect.

To be avoided

Artificial traffic calming features which have a detrimental impact on legibility and townscape should be avoided, for example: a standard width street with a winding geometry creating an indirect route.

Figure 5.10 Traffic calming measures along a street

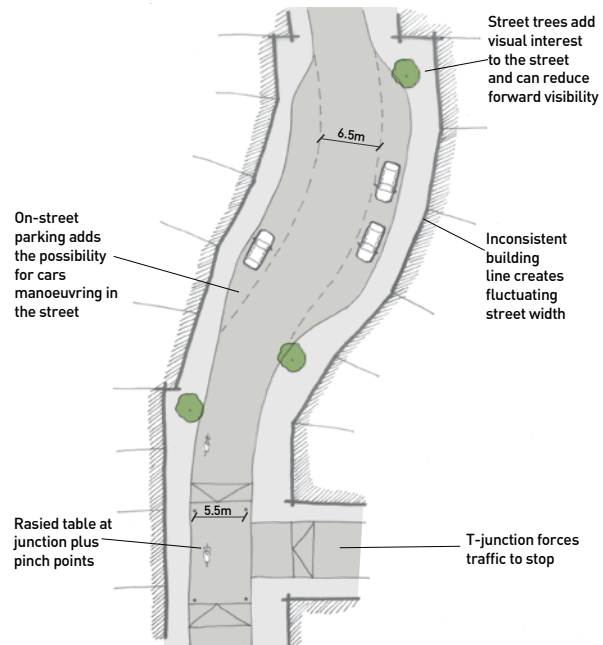

Bad example - artificial winding street with no relation to urban form



Good example - deflection of road using landscaping and a pedestrian cut-through, Hook Norton

5.8 Car parking

A range of different parking solutions should be used. The choice of parking solution should be appropriate to the character of the street and the building typology.

Amount of car parking

The Council intends to review parking standards in the forthcoming Local Plan Part 2. In the interim the approach set out in Oxfordshire County Council's Residential Street Design Guide (2015) applies. This includes recommended parking standards (refer to **Appendix F**), which should be used as guidance only for larger developments. Actual parking levels will be expected to be justified, as laid out in supporting documentation with planning applications such as Design and Access Statements, Transport Statements and Transport Assessments.

The parking standards recommend the inclusion of unallocated spaces, alongside allocated spaces to maximise flexibility and economy of land use. In some circumstances, parking can be accommodated entirely without allocated spaces. Work led by Phil Jones Associates for Oxfordshire County Council, reported in 'The Residential Car Parking Research', 2007, DCLG, has shown that the provision of more flexible parking solutions, such as unallocated on street parking supports an overall reduction in parking provision, by supporting flexibility of different householder needs.

Please refer to Section 7 of OCC's document for details on the application of the parking standards.



X

Bad example - too much space for parking creating a large gap on the street



X

Bad example - cars parking on kerbs due to lack of parking spaces or spaces which are inconvenient (image source: Space to Park)



✓

Good example - avenue street parking, Newhall, Harlow



✓

Good example - Informal homezone parking, Hanwell Fields, Banbury

Parking design

Designing an appropriate parking arrangement is critical to the success of any scheme. Where parking has not been well thought through it can be visually detrimental to the character of the street and can be a source of frustration for residents.

The Council will expect to see a range of parking solutions. The number of parked cars in any one area should be limited so that individual streets and spaces do not take on the appearance of a car park. Trees should be accommodated within streets and parking courts to reduce the visual impact of parked cars.

Parking should be functional, convenient and safe. People like to park as close to their house as possible, ideally where they can see their car from inside their house. If parking is placed in a position far away from a dwelling and obstructed from view, people will not park there and instead try to park informally on the street outside their house.

'Car Parking: What Works Where', English Partnerships (2006), provides a comprehensive toolkit for designers highlighting the most appropriate car parking approach according to density of development and housing typology and should be referred to alongside this Guide.

Car parking: golden rules for all locations

- Look to maximise the quality of the street and public realm
- A combination of on plot, off plot and on street should be considered according to the street design, location and housing typology
- On street parking should be promoted as the primary parking option and incorporated in the design – people understand how it works, it's efficient and it increases the activity and safety of the street
- Do not park in the back of the block until on street and frontage parking permutations have been exhausted. Use of the mews or rear courtyards should support on street provision, not replace it
- The proportion of allocated spaces should be limited. Research by Noble and Jenks shows that the more spaces you allocate, the more you have to provide.
- Don't forget Secured by Design principles

(Adapted from 'Car Parking: What Works Where')

Parking typologies

In general, the potential locations for parking are on-street, on-plot and in small parking courtyards. The allocation of car parking spaces (on-plot or in communal areas) reduces flexibility and is less efficient in meeting overall car parking needs.

On-street parking

The Council advocates the use of unallocated on-street parking wherever possible. Maximising the number of unallocated spaces will result in lower numbers of parking spaces overall as it provides an enduring, functional and land efficient arrangement (see Appendix B of OCC's parking standards). It can take a variety of forms including parking around a central reservation, kerbside parking parallel, perpendicular or angled to the pavement. Parking solutions should be an integral part of the street design, with clearly defined or demarcated bays. For both parallel and perpendicular solutions, a maximum of four bays should sit together, before being broken up by street tree planting or a public realm solution.

Terrace buildings work well with on-street parking, as the strong enclosure balances the necessary increase in carriageway width. Street trees should be used to soften the visual impact of parked cars and provide further enclosure to the street. Narrower streets can widen at certain points to accommodate smaller areas of on street parking.

Figure 5.11 On street parking examples from top: formal on-street; informal on-street (off line); parking in shared surface area

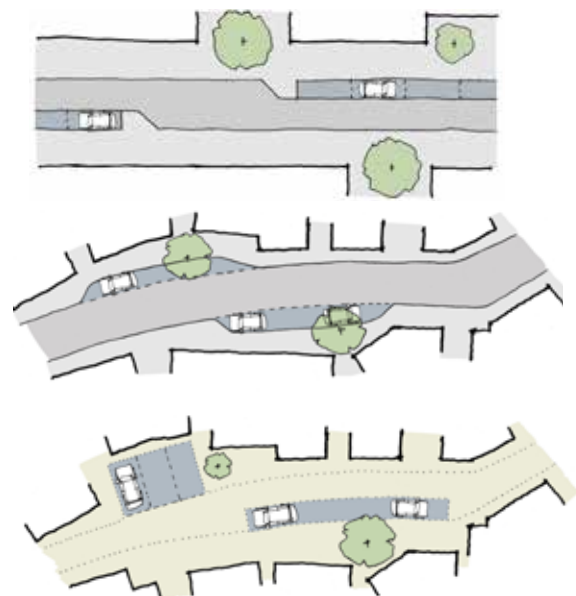

On plot parking

On plot parking to the rear or side of homes, on driveways or within garages, is by its nature allocated to a particular home. It limits flexibility and can be detrimental to street character when it is visually dominant. It is generally only appropriate for larger semi-detached or detached homes on larger plots.

Parking on-plot in driveways should, as far as possible, be designed to limit the gaps in the street frontage (for example through the use of shared driveways) and should be configured to ensure that the maximum parking standards are not breached i.e. through excessively long driveways.

Allocated on plot parking can also be provided to the rear or within gardens accessed from a rear lane. This is an alternative to the communal parking court.

In general, the Council seeks to limit the use of garages as they are often used for storage rather than parking, pushing parking demand elsewhere. Where garages are provided they should have a minimum internal area of 3m by 6m and the use of double garages should be limited.

The architecture and materials of the garage should be in keeping with the main house and have a pitched roof and wherever possible should be attached to the property.

Where two single garages are proposed together they should be attached where their use supports a better design solution. They should only be used on wide fronted properties where a front door and ground floor habitable room can also be provided. Double integral garages are not appropriate.

Figure 5.12 garage and driveway parking examples:
garage to the rear of the property (top)
garages accessed from mews/court to the rear (bottom)

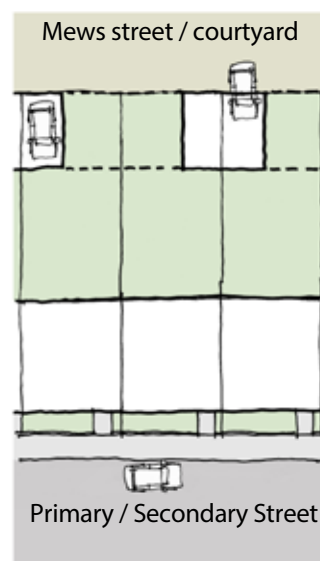
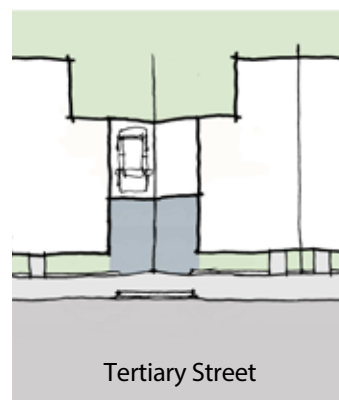

On-plot screened with vegetation, Manor Road, Fringford

Rear courtyard parking

Communal parking areas or parking lanes to the rear of properties are the least preferred solution. Although rear parking reduces the visual impact of cars on the street frontage it also reduces human activity on the street and large rear courtyards can be bleak spaces.

Where used, courts must be well-overlooked by the properties they serve, ideally with direct access to individual dwellings/gardens. They should service no more than six properties and a maximum of 12 parking spaces. Unallocated /visitor parking is not appropriate in these areas and should be provided within the street. Landscape and tree planting should be an integral part of the design.

Access to courts should be by a shared driveway between properties, via a lane to the rear, or through narrow carriage arches, to maintain a continuous frontage at first floor level. Where carriage arches are used these should incorporate first floor accommodation. Lanes may also give access to a number of properties.

Sustainability

The Council supports the use of sustainable technologies and systems designed to reduce the impact of private vehicles including:

Electric charging points

Every home should have access to at least one electric charging point and 20% of spaces in public car parks should have electric charging points.

Car clubs

The Council supports car clubs particular in low car developments. Car club vehicles are generally made available to residents on a pay as you go basis and are particularly suited to central and higher density areas where car use is only necessary for occasional trips. Discussion with the Council is required to resolve practical issues relating to implementation.

Figure 5.13 Example of private rear parking court

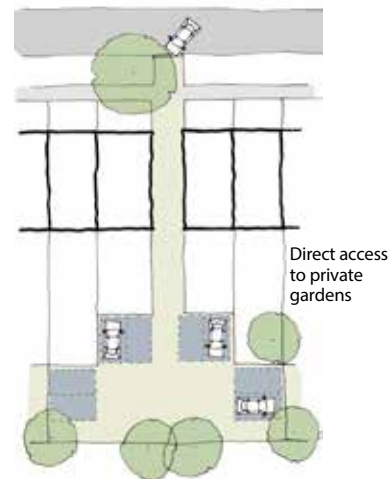

Well landscaped rear court parking, Clay Farm, Cambridge



Rear parking accessed through carriage arch, High Street, Adderbury

5.9 Avenue trees, planting, SuDS and landscape

Trees and soft landscape are important to the character of Cherwell's streets and should be incorporated in all street character types.

Many of Cherwell's historic streets have a strong building frontage, softened with by trees and landscape planting. Individual and groups of trees, grass verges and public green spaces contribute to making distinctive and attractive places.

Soft landscape, especially trees, should be incorporated into every street to support the proposed character. For example, a formal street may suit an avenue of trees and small front gardens, whereas an informal lane may be appropriate for soft verges and occasional individual or small groups of trees.

The requirement for Sustainable Drainage Systems (SuDS) is an opportunity to bring character to streets, through integrated landscape and drainage design. By considering SuDs at an early stage they can be incorporated successfully alongside street trees, utilities and car parking. See section 4.7 for further guidance in relation to SuDs.

The choice of tree species and location of trees in relation to built elements should be in accordance with the minimum distances established in BS 5837: 2012, Trees in relation to design, demolition and construction. Further detailed design guidance relating to tree planting including their relationship with utilities corridors and SuDS is contained within the Trees and Design Action Group publication 'Trees in Hard Landscapes, A Guide for Delivery', 2014.

The following principles should be considered:

- Street tree planting should be integral to the public realm design
- Street tree planting should be a minimum of a semi mature standard size in a location of sufficient size for the long term survival / health of the trees
- The species selection should consider their functional and space making qualities and native species are preferred

The maintenance and management responsibilities for landscape areas should be defined within the planning process. The design should avoid small (often narrow) planted areas which are hard to maintain.



Soft landscape reduces the impact of parking, Trumpington Meadows, Cambridge



Built frontage softened by trees and grass verges, Banbury



Incorporating existing trees and hedgerows into a new development



Incorporating SuDS along kerbside, Trumpington Meadows, Cambridge

5.10 Public spaces

Squares and greens provide important breathing space within the street network, should be framed by buildings and be located to encourage community interaction.

The widening out of the street network to accommodate village greens, squares and market places are characteristic of many of Cherwell's settlements. These spaces are framed by buildings, contain significant trees and are often located centrally adjacent to public buildings where they form a 'heart' to the settlement.

Developments should incorporate public spaces which sit with the character of the overall settlement structure and the site masterplan. Public spaces perform a number of important roles:

- They are focal points for the community, often surrounded by civic or community uses
- They create variety in the townscape and are important for wayfinding and legibility
- They can create a positive, usable space in an awkward corner
- They are an intrinsic traffic calming feature and can be of a shared surface design (see section 5.7)

Public spaces can take a variety of forms including formal hard landscaped public squares, village greens and smaller incidental spaces either hard or soft. OCC's residential road guidance includes 'social spaces' which are smaller areas where the footway might widen out to incorporate some benches, perhaps with shade from a tree. In all cases, public spaces should be framed and overlooked by buildings and designed to encourage their use – for example, through the provision of children's play or seating areas.

The size of the space should be appropriate to the scale of buildings which surround and enclose it. This should be tested in three dimensions. Trees should be used to create a sense of enclosure to larger spaces. Spaces which are too small to have any useful public function (i.e. 'leftover space') should be designed out.



Hard-landscaped incidental square with trees and seating, North West Bicester



Informal green space with trees and seating, Bloxham



Central green space, The Triangle, Swindon

5.11 Street materials

The materials of the public realm should coordinate with the palette of materials used for the buildings and should reinforce the proposed character of the street or public space. This will vary depending on the location of the scheme within the District. Details of locally appropriate building materials are provided in section 7.3.

In general:

- Pavements and main street surfaces will be tarmac, with special consideration given to edge areas, gullies and kerb details where natural stone should be used
- Shared surface areas should use block paving with setts used for drainage gulleys and careful use of high quality edge details to help define the space
- Squares and other areas of public realm should use natural stone, dependent on the character of the settlement

Large areas of concrete block paving are generally not acceptable as they are visually intrusive. Where block paving is used, the colour should be in keeping with the wider palette of building materials.

Investment in high quality materials will be expected at sensitive and prominent locations for example: within the setting of heritage assets, to define the entrance of the development, at important crossing places and public spaces and for shared surface treatments.



Tarmac with subtly coloured block paving indicating informal pedestrian crossings, South West Bicester

5.12 Utilities corridors, lighting and signs

Utilities corridors, lighting and signage should be considered early on and grouped to minimise impact on the character of the street.

Utilities

The design of utilities corridors should follow the recommendations of the National Joint Utility Group (NJUG) publications, and include liaison with service providers at an early stage.

The use of shared utility enclosures or grouped service strips should be used to reduce the service corridor width and limit impact on street design including the location of street trees. Protective and preventative measures should be adopted to avoid tree root intrusions into service corridors.

Where routing through the pavement will have a detrimental effect on the character of the street, alternatives include routing down a back street or through communal areas.

Further guidance is provided in section 3.4 of 'Trees in Hard Landscapes', Trees & Design Action Group, 2014 and Sewers for Adoption, 7th edition, WRc plc, 2012.

External lighting

Lighting should be an integral part of the street design process as there is a risk that landscape, parking and other elements are undermined when this is considered retrospectively. In particular the lighting and tree planting strategy should be considered together at an early stage.

OCC must be consulted at an early stage to agree the design brief for street lighting. OCC can provide street light design for a fee which removes the need for approval. Refer to Appendix A2 of their Residential Road Design Guide, 2015 for details.

Signage

Signage is important for wayfinding but should be minimised to avoid visual clutter. Street names and other signs should be fixed to buildings, boundary walls or lamp-posts to avoid additional columns on the street.

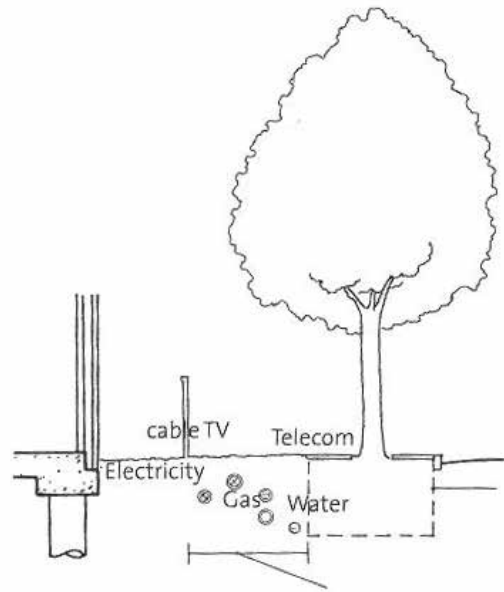

Figure 5.14 Grouped service strips help minimise maintenance disruption and avoid features such as trees (source: Urban Design Compendium, p82)



Road name and signage mounted on boundary wall and lamp-post respectively, Adderbury

5.13 Waste management

Suitable provision for the storage and collection of waste should be integrated into the street layout building and plot design.

Agreement is required on the way waste is to be managed and in particular:

- The method for storing, segregating and collecting waste
- The amount of waste storage required, based on collection frequency, and the volume and nature of the waste generated by the development, and
- The size of anticipated collection vehicles

Collection points must be no further than 20 metres from the refuse vehicle access point. As a result, a connected network of streets will enable easier movement of refuse vehicles, avoiding the need for reversing or multi-point turning manoeuvres. It is expected that the principles outlined in section 5.3 will be followed to minimise the necessary street width. BS 5906:2005 provides guidance and recommendations on good practice.

At the time of writing, the majority of dwellings in Cherwell are allocated three wheelie bins. Bins should be accommodated within the curtilage of buildings, within appropriate ventilated bin stores/enclosures in front gardens, integrated within the building, or at the side or backs of dwellings where there is sufficient access for residents to wheel bins to the front of the property on collection days. If bin stores are visible from the street, these should be of a simple design screened by vegetation or enclosed by walls of the same material as the property.



Example of an attractively designed bin store (source: West Oxfordshire Design Guide)



Side passage to enable bins to be brought out, Bletchington

6 BUILDING AND PLOT ARRANGEMENTS



- 6.1 Layout and urban form
- 6.2 Establishing character
- 6.3 Perimeter blocks and active frontages
- 6.4 Scale
- 6.5 Building typologies
- 6.6 Landmarks, vista stoppers and corner turners
- 6.7 Amenity space
- 6.8 Materials

Chapter 4 explains how the masterplan establishes the overall urban block pattern, street hierarchy and proposed character areas.

This chapter deals with the next level of detail, considering how building forms should be arranged to create a pleasing overall townscape which frames the public realm and reinforces the proposed character areas. The way buildings sit together is one of the most important drivers of character.

Chapter 7 provides further detail on the design of the buildings themselves.

New development in Cherwell should promote:

- An harmonious composition of buildings that contributes to the overall legibility and character of the place and its role within the wider masterplan
- Traditional settlement form and character
- Three dimensional form as a starting point for design
- The use of building types which reflect local traditions and can be successfully grouped together
- The use of bespoke house types to address important, sensitive and tricky conditions including landmark locations and corner plots
- The use of terrace house types, which should be the predominant form in most developments, especially along principles routes, mixed use areas and adjacent to public open space. Limited use of detached and semi-detached houses.
- Design solutions that minimise the opportunities for crime and antisocial behaviours through the clear definition of the public / private boundaries and creation of active frontages

New development should avoid:

- A lack of three dimensional design thinking
- Estates with a homogenous, ‘could be anywhere’ character
- Architectural focus on individual buildings rather than the overall street composition.
- The use of inflexible, standard house types which cannot be grouped effectively
- The use of detached houses on small plots when a terraced form is more appropriate

Please refer to the following chapters for supporting information:

- **Chapter 2:** For a summary of the District’s distinctive characteristics and character areas
- **Chapter 4:** For details of how a scheme’s character is established through the vision and structuring principles of the masterplan and block structure
- **Chapter 5:** For details of how the character of individual streets will be established in the public realm
- **Chapter 7:** For detailed guidance on the design of individual buildings
- **Chapter 8:** For guidance on sustainability considerations
- **Appendix A:** List of Conservation Areas within the District

Further reading:

- **Conservation Area Appraisals, CDC:** Provides detailed character analysis and guidance for each of the District’s conservation areas
- **Responsive Environments, A Manual For Designers, 1985, Bentley, Alcock, Murrain, McGlynn, Smith:** Provides detail on the composition of the street, contextual clues for built character and external surface design

6.1 Layout and urban form

Detailed layout design should focus on the composition and arrangement of buildings across the street as a whole, rather than the design of individual buildings in isolation.

The way in which buildings are grouped together to create the urban form of the street has a strong influence on character and should be a direct response to the proposed vision for the development (see section 4.3 for details). This should be clearly articulated in the planning application Design and Access Statement.

It is expected that urban form will vary from street to street reflecting its role within the masterplan hierarchy and in response to localised conditions e.g. a change in level or street orientation. This will support the legibility of the settlement.

Individual buildings should be designed to relate well to their neighbours, creating a harmonious overall composition and work with site conditions. The use of inflexible standard house types should be avoided as it severely limits the potential for cohesive and responsive design.



Consistent street frontage, Bicester

New development should:

- Create a pleasing rhythm, variety and articulation to the street, through the use of different building forms, landmark features and the design of the façade and roofscape (see chapter 7)
- Respond to overarching character objectives e.g. informal or formal (see 6.4)
- Create bespoke design solutions for sensitive locations e.g. landmark locations, at corners and where views are terminated (see section 6.8)
- Consider the way buildings relate to other elements eg. car parking arrangements, front gardens, pavement widths
- Design out crime through the creation of active frontages and perimeter blocks (see sections 6.3 and 6.4)
- Make the settlement easy to navigate by creating a series of memorable spaces, landmarks and views
- Encourage natural traffic calming through the careful arrangement of buildings in relation to the carriageway (see section 5.7)

The Council will expect to see evidence of design thinking in three dimensions, including the use of simple physical or computer models, sections and perspective drawings encapsulated within the Design and Access Statement and used as a design tool to assess the form of the layout, including the roofscape.



Strong vertical rhythm with simple variation in design, Banbury



Corner solution, where building addresses both streets, Banbury



Corner of building juts out into the road, creating a natural pinch point forcing cars to give way to oncoming traffic, Islip

6.2 Establishing character

Urban form is an important element in defining the character of a place.

The proposed character of individual streets and blocks will be established in broad terms as part of the site wide masterplan and vision; this is explored in section 4.3.

An important element of character is the degree of formality in the layout and urban form. In historic settlements this is a reflection of the extent to which a settlement was planned (formal) or developed incrementally and organically (informal).

In designing new places, designers should draw from both approaches to establish variety and reinforce the overall hierarchy of streets and spaces within the masterplan.

Formal Streets

Greater formality will be appropriate in some areas of the masterplan, for example to emphasise the civic character of a public space or to front an important movement route. Formal streets should be laid out in a regular, rectilinear pattern.

Characteristics of the urban form of formal streets include:

- Consistency and unity across the majority of elements of the urban form i.e. plot and building size, roof lines, eaves lines, building line, materials and façade design
- Buildings at the middle or ends of the street may be taller, brought forward, or have increased ornamentation to provide emphasis and visual interest
- Classically proportioned building facades (see section 7.2)
- Detached homes should have a wide frontage, narrow plan; semi-detached, in a villa form; and either plan form used for terrace properties (see section 6.5)
- Windows and doors will be regularly spaced, with a repetitive pattern established for the street as a whole. Changes in the pattern can be used to emphasise key buildings or locations
- Formally arranged street trees creating an avenue and regularly sized front gardens



Figure 6.1 Formal street



Formally arranged terrace, Bicester



Formal repetition of semi-detached homes, Banbury



Formal modern terrace - repetition of materials, regularly spaced windows, doors and trees, North West Bicester

Enclosure and openness

In both formal and informal layouts, the majority of buildings should be arranged in a terraced form to create a near continuous built frontage to the street, in line with the principles for perimeter blocks set out in section 6.3.

However, in some character areas a more open arrangement may be appropriate for example to allow views out to the wider landscape or to meet a particular need for larger semi-detached or detached properties. In these locations, the gaps between buildings should be clearly defined by boundary walls, fences or hedges. On plot parking should be arranged so as not to dominate the street frontage (see section 5.8).

Informal Streets

Where an organic, village character is proposed, streets should have an informal layout, with a simple geometry, varying to reflect topographic and natural features. Particular care is required to create overall visual coherence and harmony. The right balance can be achieved by varying one or two elements of the urban form, but not all.

Characteristics of the urban form of informal streets include:

- Groupings of buildings with continuity of building line and materials, which provides coherence in a street scene, while other elements, such as plot width, building height and fenestration vary
- A range of plot and house sizes on a street to reflect traditional patterns
- Variety in the character of individual buildings. Within the street there should be a mix of wide and narrow frontage properties (see section 6.5), typically with consistency in the building line and materials
- Informally arranged windows and doors
- Subtle variation in roofscape reflecting variations between neighbouring building heights
- Street trees located individually or in small groups to form a focal point where the street widens or in public squares and green spaces.
- Front gardens which vary in size reflecting changes in street and plot alignments. Planted and grassed verges may also be present, where development is set back from the street



Figure 6.2 Informal street



Continuous building line but wide variety in heights and sizes, Banbury



Continuous building line but wide variety in design and height, Bicester



Variation in set-back moderated by front garden boundaries, Duns Tew

6.3 Perimeter blocks and active frontages

A general principle for the arrangement of building plots is 'public fronts, private backs' to ensure clarity between public and private spaces.

The elevation of buildings fronting the public realm should be 'active', to encourage human interaction and passive surveillance of the public realm.

This arrangement creates a 'perimeter block' with buildings fronting and providing a frame to streets and open spaces. The perimeter block arrangement is an effective means of designing out crime in that it provides a defensible front boundary with good surveillance from the street and a secure rear property boundary.

Layouts which confuse the relationship between fronts and backs or emphasise property access from the rear should be avoided.

Buildings face the street...

... and form a secure perimeter block

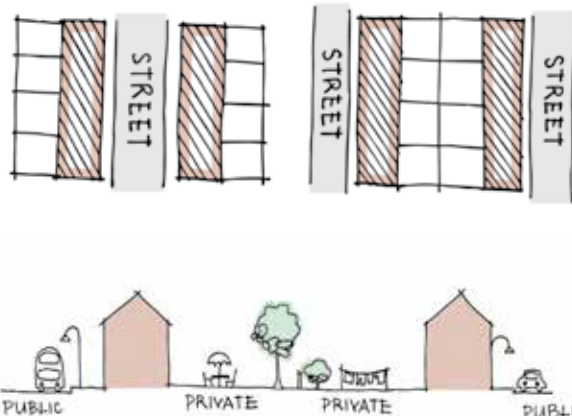

Figure 6.3 Front and back relationships



Mixed use urban square, Poundbury

Principles for perimeter blocks:

- Orientation for solar gain, wind patterns and microclimate must be considered in the form and structure of the block and frontages (see section 4.9)
- The boundary between the public realm and the private realm must be clearly defined by either the building line or garden boundary
- The principal frontage and main entrance to the property must face the main street (not the side street). This applies to all house types including apartment buildings
- The principal frontage must include front doors and larger windows
- Internally, living spaces and habitable rooms must be located on the principal façade overlooking the public realm
- Bathrooms and cloakrooms and the use obscure glazing must be avoided facing onto the public realm and / or principal elevations. Kitchens are only permissible in this area where windows can be appropriately proportioned and detailed
- Elements which deaden the street such as blank building facades, garages and integral parking, and bin stores are not appropriate in the public realm
- Elements of non-residential uses which help to 'activate' the frontage to the public realm such as cafes or shops should be encouraged to spill out onto the street

Chapter 7 provides further guidance relating to the design of active facades.



Figure 6.4 Active frontage encourages human interaction

6.4 Scale

Building scale should respond to local context and proposed character.

Scale should be considered in relation to the enclosure of the street and the public realm, to give a comfortable height to width relationship and relate to the structure of the masterplan. This is explained in section 5.2. Perception of building scale is not only influenced by the number of storeys, but also by the form of the roof, the eaves height and internal floor to ceiling heights and local architectural character should inform the building height and form.

Principles for scale:

- In the majority of areas, building heights of two or three storeys are appropriate. Additional accommodation may be included in the roof space and/or in a semi-basement. Rooms in the roof space are encouraged
- Taller buildings may be appropriate in town centre locations, but individual buildings should be designed to fit comfortably with the general urban form
- A steeply pitched roof is an important component of the traditional Cherwell form. Shallow pitched and hipped roofs with a suburban character should be avoided (see chapter 7)
- For an informal area the eaves and ridge height can vary (minimum 200mm) from building to building to create an varied roofscape
- In formal streets, the eaves line and roof ridge should be consistent between neighbouring buildings
- Grander buildings, with higher floor-ceiling heights can be a positive addition



Two to three storey buildings, Adderbury



Two storey buildings some with rooms in the roof, Islip

6.5 Building typologies

Building forms should be simple and reflect the character and traditions of the local area.

Simple, traditional building forms based on a rectangular plan should be used. These forms can be easily grouped together to form a continuous street frontage accommodating a range of different building sizes. In most cases buildings should be designed to be in a terrace form.

There are two basic plan forms:

1. Wide frontage, narrow plan

- Simple facade with either symmetrical, classical proportions (up to three storeys) or cottage vernacular proportions (up to two storeys), with occasional half storeys
- Can be linked to form a terrace or be detached or in pairs
- Rectangular rear extensions can be used to create an L-shaped plan, if this is appropriately detailed. This will typically be setback from the building line, but may in prominent building locations form an integral part of the design

2. Narrow frontage, deep plan

- Simple facade with classical proportions (two-three storeys) or occasionally cottage vernacular proportions (up to two storeys), with occasional half storeys
- Should be linked to form a terrace or occasionally 'handed' to form a symmetrical semi-detached pair
- This form is generally not appropriate for detached houses
- Care should be taken to ensure that where wide gables occur, they are not visible from the public realm

Figure 6.5 Basic typologies



Wide frontage, narrow plan terrace



Wide frontage detached

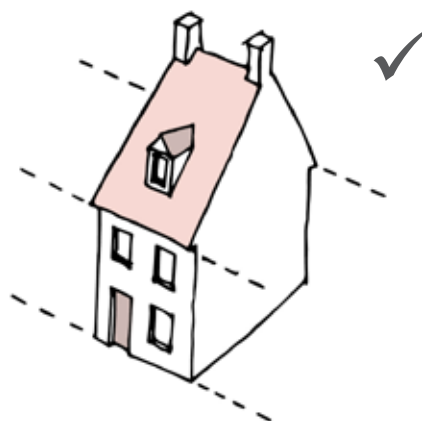

Narrow frontage, deep plan terrace

In both cases:

- The front façade of the property should be kept flat, apart from simple porches
- Roofs should be a simple pitch with ridgelines aligned parallel to the street and chimneys located on the ridgeline
- On occasion, a narrow frontage property may be arranged with its gable end to the road (see chapter 7 for guidance on building facades, roofs and chimney details). However, care should be taken to ensure that the gable proportions are well balanced
- The frontage of individual buildings or the terrace can be faceted or curved to respond to a change in street alignment, with adjustments to the internal building plan
- Garages and other outbuildings should relate well to the form of the main building
- Projecting bay windows should only be used occasionally
- Dormers can be used occasionally, when arranged in proportion with the property and neighbours, but overuse can disrupt the roofline

Figure 6.6 Examples of typical typologies



Wide fronted terrace, Adderbury



Narrow fronted 3 storey terrace, Banbury



Wide fronted, detached behind a garden, Bloxham



Narrow fronted, semi-detached, Islip

The following should be avoided:

- Projecting front gables (uncommon in Cherwell vernacular)
- Deep or square plan forms
- Hipped or pyramid shaped-roofs (overtly suburban character and difficult to group)
- Exposed wide gable ends (uncommon in Cherwell vernacular)
- Narrow fronted, detached houses (results in a gappy frontage)

Relationship between building size, form and plot

There is no limit on the size of property which can be successful accommodated in a terrace form, with examples ranging from workers cottages to mansion townhouses. A detached form should only be used for larger properties (a net floor area of over 100 sqm).

To avoid the appearance of ‘cramming’, detached properties should only be sited on larger plots which have sufficient generosity to balance internal and external space requirements effectively and accommodate car parking without garages and driveways dominating the street frontage.

Chapter 4 provides further guidance on the relationship between building typologies and density.

Apartment buildings.

In general, apartment buildings should be designed to be indistinguishable from individual houses and subtly integrated into the street e.g. taking the form of a wide frontage, detached house.

In local centres or at transport hubs, a higher density and greater proportion of apartments may be appropriate. In these locations bespoke solutions for larger apartment buildings should be developed with Cherwell District Council.

Figure 6.6 Typologies to be avoided

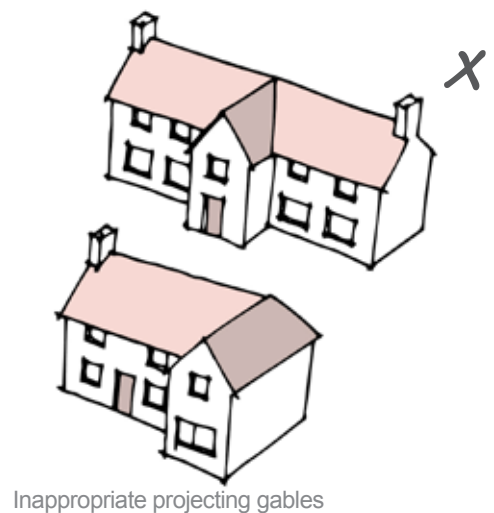
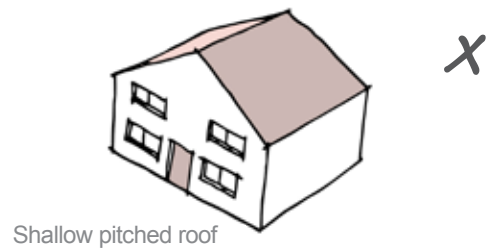
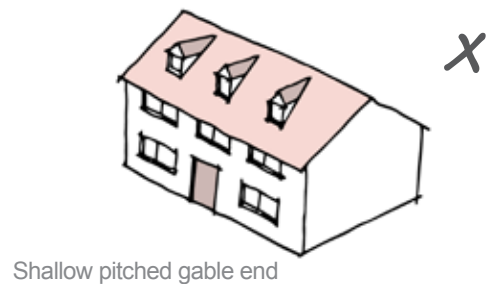
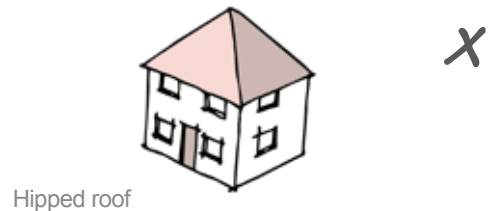

6.6 Landmarks, vista stoppers and corner turners

Bespoke design solutions are required for important and sensitive locations including landmarks, corners and to terminate vistas.

These buildings lead the eye onwards and play an important role in helping people to understand and find their way around the settlement. While focal buildings are important, it is equally important that they work in context with those adjacent. The location of landmark buildings should be considered in the context of the masterplan and hierarchy of streets and places.

Landmarks

Landmarks should be located in prominent positions to help people navigate and remember the organisation of streets and places. They should be designed to draw attention, add interest and focus. They can be an individual building or a group or even a landscape feature. A landmark might include some of the following characteristics:

- Greater scale than its neighbours
- Grander proportions to its facade
- Increased ornamentation
- Distinctive architectural style or form e.g. a detached, classically proportioned house in an otherwise informal, terraced street
- Variation in materials

Vista stoppers

Vista stoppers are required to spatially enclose and frame views e.g. at the end of a street. Vista stoppers are not necessarily landmarks, but should be well proportioned and attractive building frontages or a public space framed by buildings. A vista stopper may also give sense of direction e.g. a curving group of buildings which lead the eye onwards.

- Where a building is used to terminate a formal street vista it should be arranged centrally to the view to give a sense of symmetry
- 'Dead' frontages such as blank facades or fences, garages or parking areas must not be used as vista stoppers

6



House at end of a street, South West Bicester



Landmark view, Bloxham



Prominently positioned house, Lower Heyford

Turning the corner

Corner sites are visually prominent. Where two streets form a junction, a bespoke design solution is required for the corner plot. This should respond to the hierarchy of each street.

- The corner should typically be turned by a group of buildings, especially on principal and high order streets and places
- A single building with two active fronts in (as shown in figure 6.7) may be acceptable along lower order streets
- Both frontages should be 'active'
- Greatest emphasis should be given to the principal street frontage in the overall hierarchy, with front doors and principal windows

- The continuous frontage of a terrace could curve with the street. The plan of individual properties will need to be splayed to accommodate this
- If the corner is also to form a landmark, additional emphasis can be given to doorways and windows or the height can be raised subtly above the surrounding buildings, or a non-residential use incorporated at the ground floor



Figure 6.7 Plans of corner buildings

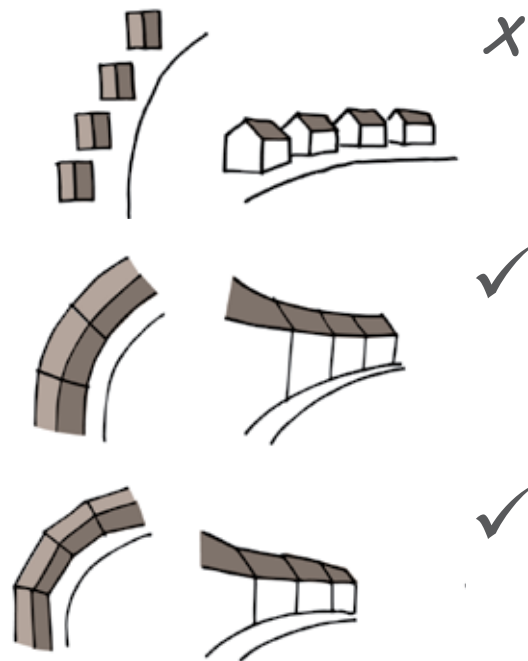

Figure 6.8 Diagram of continuous frontage (adapted from Essex Design Guide, Essex County Council)



Single corner building, Bloxham



Corner terrace in new development, Adderbury

6.7 Amenity space

Outdoor amenity space should be provided in the form of rear private gardens for houses and balconies, roof gardens or shared gardens for flats.

The amount of gardens and outdoor space should be appropriate to the size of the property, with an expectation that larger properties will be located within larger plots with larger garden, reflecting the likely needs of larger families.

Principles for amenity space

- Amenity space must be usable and receive sunlight for the majority of the year. Building heights, orientation and access to light must be considered to prevent overshadowing, particularly in north facing gardens
- Areas must not be overlooked, lack suitable privacy, or have other primary functions e.g. car parking, refuse storage and footpaths are not amenity space
- A minimum distance of 22m back to back, between properties must be maintained
- A minimum of 14m distance is required from rear elevation to two storey side gable
- First floor habitable room windows must not be within 7m of neighbouring property

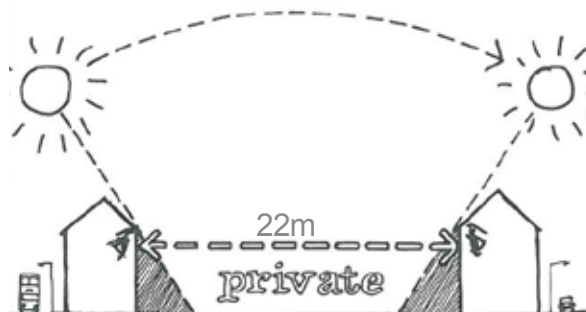

Figure 6.9 Amenity space and sunlighting (source: Responsive Environments, Bentley et al. p15)



Existing mature tree incorporated within private garden space, Upper Heyford.



Mews street, approximately 7m wide, Trumpington Meadows, Cambridge

Boundary definition

There should be a clear definition between the public realm and private amenity space, through enclosure by walls, fences, hedges and other threshold features. This is important in establishing a sense of ownership. Boundaries often form important features in the public realm and contribute to the character of an area.

In general the boundaries to front and rear gardens should be as follows:

- Front garden walls (between the public realm and private front gardens) should be approximately 90cm high and in the same material as the front wall of the house, unless this is render, in which case the coping should be brick or stone. Gates in these front garden walls may be in painted metal or wood or stained wood, and should be the same height as the front garden walls.
- Metal railings are also appropriate, either on top of a low wall or as a stand-alone feature, especially on formal streets
- Rear and side garden walls separating the public realm from private spaces and including the boundaries to parking courtyards should be at least 1.5m high and should be in the same material as the front external wall of the relevant house
- Fences should not be used where visible from the public realm
- Gates within these garden walls should be in painted vertical timber boarding and should match the height of the relevant walls



Traditional boundary treatments

6.8 Materials

The choice of materials should vary across the masterplan in response to the proposed local character.

Materials are an integral part of the character of streets and places and should be used to reinforce the character of different places. The majority of the development should have a simple palette of high quality materials. Natural local stone and slate will be expected in key and sensitive locations, for example, on prominent frontages, key entrances into the site and in areas adjacent to public rights of way and the open countryside (see chapter 7).

The choice of material should create visual harmony across the street as a whole, with a limited palette of materials. An indiscriminate pepper potting approach should be avoided.

Section 7.3 provides details of appropriate materials in different parts of the District.



Simple palette of materials, Barford Road Bloxham



Use of local stone, Woodstock



A simple palette combining modern materials and local stone applied across buildings and the street, Radstone Fields Brackley



7 BUILDING ELEVATIONS AND DETAILS



7.1 Sustainability considerations

7.2 Façade proportions

7.3 Building materials

7.4 Detailed guidance

7.4.1 Windows

7.4.2 Roofs

7.4.3 Doors and porches

7.4.4 Decoration

7.4.5 External boxes

Building proportions, details and materials contribute to making a home functional and liveable. Of equal importance is the impact that the detailed design of individual buildings has on the character and visual coherence of the street as a whole. This chapter considers how the character and composition of places should be articulated and reinforced through the detailed design of building elevations.

The guidance contained in this chapter is more detailed and prescriptive than earlier chapters, setting out simple rules on proportional relationships, materials and detailing.

The vernacular architecture of Cherwell has a simple form and use of details and it is this simple pared back architecture that gives the area its distinctive character. The detailed design of buildings including the choice of materials is important in reinforcing the character of the scheme which is established through the masterplan.

Buildings should be designed as part of an overall street composition rather than designing individual buildings in isolation. Details are also important in providing living environments which are functional and comfortable. The vernacular architecture of Cherwell is very simple and care should be taken to ensure that a limited palette of materials and details are considered.

CDC promotes innovative and sustainable architecture and are happy to consider modern architectural solutions, where they are of exemplary design and in the right context. Further information is set out in chapter 8.

Where a more traditional approach to building design is being taken, it is important that this does not follow a generic 'traditional' style, which has little relationship with Cherwell. The guidance set out in this chapter promotes an approach to architectural design and materials that reinforces the area's character.

New development in Cherwell should promote:

- Well proportioned, simple facades in keeping with the character of the District
- Details which perform a functional role, protecting the building from water ingress etc. and which are designed to be long lasting and low maintenance
- Details which reinforce the role of each building in creating a visually coherent scheme
- Bespoke house types which integrate locally appropriate details as part of their construction. The Council will expect to see bespoke design solutions reflecting local character for elements including windows, doors, porches, bay windows, dormers, roofs and chimneys. Careful attention should also be paid to the finer details such as eaves, verges, quoins, plinths which must be in keeping with local tradition (see detailed guidance in section 7.4)
- The use of high quality, locally appropriate materials across the scheme
- Affordable housing which is indistinguishable from market sale homes
- Careful location of windows and doors within the facade which:
 - informs the overall organisation of a building and the character of individual rooms. For example: larger windows and greater floor/ceiling heights bring a sense of space and light
 - has an impact on the energy efficiency of the building (see section 7.1) and the need for artificial light and heat

New development should avoid:

- A focus on the design of individual buildings rather than the overall street composition
- A scatter-gun approach to detailing and the use of materials, creating a visually incoherent scheme
- Use of inflexible, standard house types and detailing which are not reflective of local character
- Poorly proportioned facades
- The use of stick-on or skin deep elements to add 'character'
- Poor quality materials and poorly designed details which bring problems of repair and maintenance

Cherwell promotes well detailed simple form, using high quality materials and robust construction techniques. We expect details which are an integral part of the building design and the street composition. The use of 'stick-on' details to add character is not acceptable, neither is a scatter-gun approach to the detailing of individual houses with no consideration of the overall composition of the street.

The use of high quality, locally appropriate materials and details should be factored into the scheme cost analysis from the outset.

Please refer to the following chapters for supporting information:

- **Chapter 2:** For a summary of District's distinctive characteristics and character areas
- **Chapter 4:** For details of how the scheme's character is established through the vision and structuring principles of the masterplan and block structure
- **Chapter 5-6:** For details of how the character of individual streets and places will be established in the public realm and the composition of buildings
- **Chapter 8:** For further details on sustainability considerations
- **Appendix A:** List of Conservation Areas within the District

Further reading:

- **Conservation Area Appraisals, CDC**
- **Windows and Doors in Historic Buildings - Planning Guide 1, 2007, CDC**
- **Colour Palettes: Banbury, Bicester, Kidlington, 1996, Roger Evans Associates for CDC**

7.1 Sustainability considerations

Buildings should be designed to provide good, practical and economic natural lighting, ventilation and thermal insulation.

Across the District, new development should seek to increase standards of sustainable design, the principles of which should be established through the masterplan layout and block structure. In particular, the orientation of development blocks has a significant impact on the potential to reduce the need for heating through passive solar gain and the potential for successful PV and solar water heating. Section 4.9 and chapter 8 provide further details on this issue.

CDC is planning to produce a Sustainable Building Supplementary Planning Document which will provide guidance on a range of measures, such as reducing energy and water use in the design of new buildings. This approach should be applied in an integrated way which is complementary to the wider character-led objectives of this Guide i.e. the use of locally appropriate building forms, materials and details.

Opportunities to consider include:

- Window design in response to passive solar gain and building orientation
- High standards of insulation including glazing
- Thermal mass of building materials
- Natural/passive ventilation or efficient mechanical ventilation
- Low temperature heating systems such as underfloor heating
- Solar water heating
- Photovoltaic panels
- Ground sourced heat pumps
- Heat exchangers
- Low embodied carbon materials

Chapter 8 provides further details.

The Local Plan sets out in policy ESD 3 guidance on sustainable construction. In addition, the detailed design of buildings and the public realm should support increased levels of sustainability in broader terms for example:

- The inclusion of bat and bird boxes, and hedgehog fence holes to support biodiversity
- Encouraging recycling through appropriate storage and easy access (see chapter 6)
- Easy access to bicycle storage and provision of electric car charging points to encourage sustainable movement choices (see chapter 5)

Sustainability exemplar

Sustainable building is an integral part of all development. We promote exemplary standards of sustainability and innovation in architecture and further information on this is set out in chapter 8.



Photovoltaic panels, Trumpington Meadows, Cambridge

7.2 Façade proportions

The traditional arrangement of windows, doors and other elements varies from building to building, but can generally be described on a spectrum from the formal, classically arranged facades, to the more informal, with a cottagey character found in less grand properties particularly in the villages.

Formal vs informal

The choice of whether to apply a more formal or informal arrangement should be a response to the proposed character of the building, the street as a whole and its relationship to the wider context.

In determining whether a façade has good proportions the following rules of thumb should be applied (although innovative, modern architecture styles often breaks these rules successfully).

For all buildings:

- Window openings should normally diminish in height as the building rises, so ground floor windows should be taller than first or second floor windows
- The arrangement of windows should consider the balance and proportion of the overall street façade
- Horizontal strips of windows should always be avoided

Formal / classical:

- Generally appropriate for townhouse, detached and semi-detached properties
- More symmetrical arrangement of windows often around a central front door, with windows aligned both vertically and horizontally and regularly spaced
- Windows typically have a strong vertical emphasis and may utilise the golden section (1: 1.618) or 1:2 width to height ratio
- Window generally occupy between 25-35% of the principal elevation
- Windows should be sash, with a symmetrical pattern
- Where dormers are used, they should be lined up with the windows below

Figure 7.1 Simple formal and informal facades

FORMAL

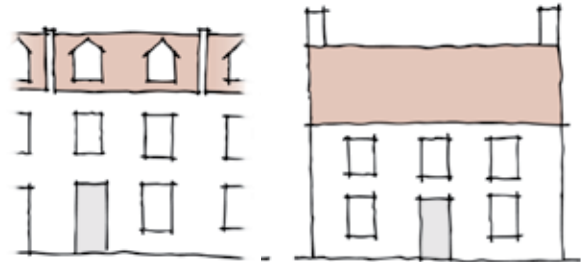

INFORMAL



Figure 7.2 Unsuccessful facades



Informal / cottage style:

- Generally appropriate for smaller properties with lower floor to ceiling heights
- Less symmetrical arrangement of windows and front door, with varying window to wall relationships
- Windows generally occupy between 15-25% of the elevation
- Casement windows which are taller than they are wide should be divided by timber or stone mullions to give a horizontal emphasis
- Upper windows are often positioned very close to the eaves
- The use of dormers should be occasional and where used should be small scale
- Single casement windows are not appropriate

Figure 7.1 illustrates simple formal and informal arrangements. Figure 7.2 illustrates for comparison, an unsuccessful arrangement which is not quite symmetrical, has mean windows on the ground floor and an oversized dormer.

Apartment buildings

As discussed in chapter 6, apartment buildings should generally be designed to resemble a larger detached or townhouse property following the formal façade arrangement outline above.

In higher density locations, larger apartment buildings may be appropriate. The Council will expect to see a carefully articulated elevation, which has appropriate proportional arrangements and a level of variation in keeping with the overall character of the street.



Bloxham



Islip



Woodstock



Lower Heyford



Adderbury

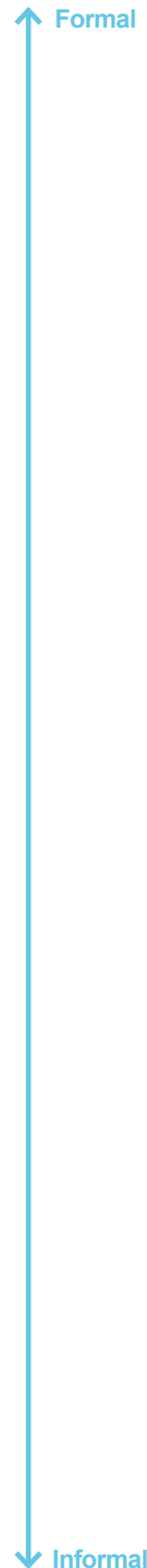

7.3 Building Materials

A simple palette of locally appropriate materials should be used to bring visual coherence to the scheme as a whole. The palette should co-ordinate materials across buildings, boundary treatments and the public realm.

The use of a simple, consistent palette of walling materials is one of the most distinctive characteristics of Cherwell's historic towns and villages. The North of the district is dominated by golden-yellow ironstone while paler limestone is used in the South. Red brick is also used, particularly in Banbury and Bicester. Chapter 2 provides further details on the distribution of materials across the District.

New development is expected to continue this tradition, through the use of locally characteristic materials for the construction of all new homes across the District. Tables 7.1 and 7.2 provides details of acceptable building materials and detailing.

Principles for use of building materials:

- Where stone is used it should be natural stone (not reconstituted or artificial stone)
- Brick should match local Banbury or Bicester brick
- The Council expect the proportions of natural stone, slate to be used:
 - 80% conservation areas
 - 60% village locations
 - 40% elsewhere
- Wood cladding, concrete and plastic substitutes for natural materials are not acceptable

- Variation in the use of materials between buildings or groups of buildings may be used as a means of reinforcing the character of key spaces or landmarks, but should generally be minimised so that the building line reads as a single element framing the public realm
- A building must be constructed in one walling material and a mix of materials is not acceptable. For example, ground floor brick and upper floor render. Where stone is used the same material should be used below the damp proof cause level. Exposed brick or other material will not be acceptable
- Garages and out buildings must be constructed in the same material as the main property
- Expansion joints should be avoided onto the public realm. Where required they should be discreetly located behind rainwater goods (i.e. gutters and downpipes)
- Soldier courses or other ornamentation is not normally appropriate
- The materials palette should be discussed and agreed with the Council at an early stage. The palette should include walling, roofing and boundary treatment/threshold materials. The palette should co-ordinate across buildings, thresholds details and elements of the public realm such as paving
- The colours of the palette should be informed by the Roger Evans Associates report 'Colour Palettes: Banbury, Bicester, Kidlington' produced for the Council







Table 7.1 Appropriate use of local stone

	Character Area					
	Bicester	Banbury	Ironstone Downs	Cherwell Valley	Ploughley Limestone Plateau	Clay Vale of Otmoor (including Kidlington)
Ironstone		Y	Y	Y (North)		
Limestone	Y		Y (south)	Y	Y	Y

Y = appropriate in this location
O = occasional use only



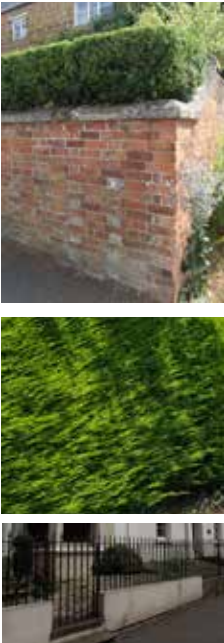

Table 7.2 Materials and detailing

Walls (external walls and thresholds)

Material	Details
Ironstone	 <ul style="list-style-type: none"> Local ironstone with dark honey tones. Lime mortar Coursing Ashlar / finish Expansion joints (where necessary) should be out of sight e.g. located behind rainwater goods
Limestone	  <ul style="list-style-type: none"> Cotswold limestone (pale, oolitic limestone) Lime mortar Coursing Ashlar / finish Expansion joints (where necessary) should be out of sight e.g. located behind rainwater goods
Brick	  <ul style="list-style-type: none"> Colour: Soft toned red brick, reflecting local historic brick Beige bricks are inappropriate Variation in batch Texture Mortar Brick bonding should be stretcher, English or Flemish bond Garden wall bond should be used for garden walls
Render	 <ul style="list-style-type: none"> Self-coloured render or painted to reference brickwork or weathered stone, but in most cases should not be the main material (refer to Colour Palettes report, Roger Evans for colour details) Robustness and maintenance should be considered
Wood	 <ul style="list-style-type: none"> Only appropriate on barns, outbuildings etc.

<p>Railings / hedging</p>		<ul style="list-style-type: none"> • Painted black metal railings. • Full height or on top of brick / stone wall with coping • Hedges can be used to create a softer edge and can be used in combination with railings. • Black railings • No timber fencing onto public realm
---------------------------	--	---

Roofs

Material	Details	
<p>Clay tile</p>		<ul style="list-style-type: none"> • Red plain clay tiles • Blue clay tiles on northern edge of district • No concrete or profiled duo imitation tiles.
<p>Slate</p>		<ul style="list-style-type: none"> • Blue / black Welsh slate • Stone slate • No imitation slates.
<p>Chimneys</p>		<ul style="list-style-type: none"> • Chimneys throughout the District should be constructed of brick. • Clay chimney pots • •
<p>Rainwater goods</p>		<ul style="list-style-type: none"> • Gutters and downpipes should be in painted metal (normally black)

7.4 Detailed guidance

The design of individual elements of the building façade including the windows, doors and the building's roof play a significant part in defining the character of a building and the wider settlement.

This section provides a set of simple rules for the detailed design of windows, dormers, roofs, doors and porches, decoration and external boxes. These apply to all new homes across the District.

7.4.1 Windows

General

Windows make a fundamental contribution to the character and appearance of buildings and settlements more widely. Guidance on the general arrangement and proportions of windows within the façade (solid / void relationships) is contained in section 7.2 and relates to the character of the building, whether formal/classical or informal/cottage style.

- The design of individual windows should be a response to building character
- Window details must match / be consistent on all elevations
- Slim line double glazing should be used
- There should be no frosted glass on any principal elevation
- Glazing bars should be structural and no ornamental plastic strips will be accepted

Casement:

- Casement windows should be side-hung, flush fitting and balanced casement widths
- The height of individual windows should always be the same or greater than their width
- Window openings wider than 450mm should be divided vertically and equally, by stone or timber mullions
- The frame on the hinge side should normally be fixed to a wall or a substantial vertical framing member/ mullion
- Windows frames should be timber or metal in Conservation Areas and other sensitive locations
- Single casement windows should not be used



Consistent window details, Upper Heyford



Casement window flush with wall, Bletchingdon

Sash:

- Sash windows must be vertical sliding with the upper and lower sash equal, and together filling the whole opening height
- Windows heights should be greater than their widths, with proportions in line with the Golden Section i.e. a ratio of approximately 1:1.618
- Windows frames should be painted timber in Conservation Areas and other sensitive locations

Recesses, cills, lintels and arches:

- Window recesses should normally be about 100mm.
- To achieve good visual contact between buildings and streets, window cill heights should not normally be more than:
 - 600mm above floor level in ground floor areas or living/dining areas at first floor level
 - 800mm above floor level in upper floor areas
- Flush cills are required (double cills are not acceptable)
- Stone and timber lintels are preferred (timber for casement windows in vernacular buildings), but brick faced lintels may also be used
- Where timber lintels are used they should be integral to the building (they should be a minimum of 150mm deep and have a 215mm margin at the edge of the window)
- Brick gauged flat arch or stretcher soldier arch are acceptable. On end brick lintels are not acceptable, neither are arched headers unless they are traditionally detailed
- Stone drip moulding may be used on stone lintels, where traditionally detailed



Sash window, Woodstock



Sash window, Bloxham

Dormer windows:

- Well-proportioned slim profile dormers should be used and be of a smaller scale than the lower windows of the elevation. Their construction must be integral with the main roofs
- Dormers should be located in one of three positions on the roofs:
 - at or below half-way up the roof slope (packed off one of the purlins), with the ridge of the dormer well below the main ridge of the house
 - at the eaves, aligned to the internal wall
 - at the eaves, aligned to the external wall face
- Gabled dormer roofs are preferred. Pitched roofs must be at least 40° to the horizontal. The facing material of the pitch should match the main roof of the relevant building. The cheeks and gable (if gabled) should be of roughcast render or lead
- The dormer cheeks should slim
- The windows themselves should be flush fitting, side-hung timber, two-light casements
- Flashing should be minimised and well detailed to ensure water runoff
- No glass reinforced plastic (GRP) to be used

Figure 7.3 Dormer window locations

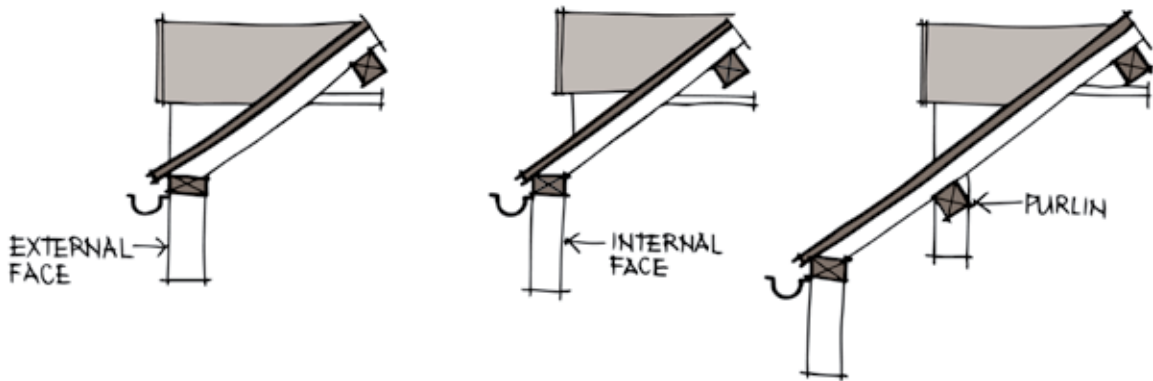
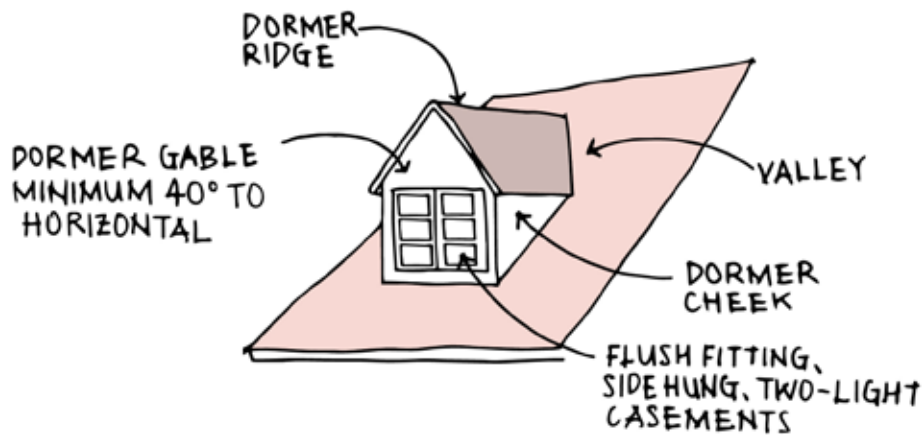

Figure 7.4 Annotated diagram of a dormer window



Rooflights:

- Rooflights are not acceptable on the front or principal elevation
- They should be flush between rafters
- Where used they should be parallel to the roof surface, with a vertical emphasis and modest in size (not normally more than 900mm in either dimension). They should be fully surrounded by roof tiles or slates
- Rooflights should be framed in wood or metal



Good examples of modern dormer windows, pitched roofs, slate tiles and brick chimneys, Woodstock



Small rooflights on rear elevation, South West Bicester

Sustainability exemplar

The size, type and arrangement of windows in relation to the path of the sun and prevailing winds can have a significant impact on the need for heating and lighting. Where appropriate to the character of the building and street, habitable rooms and larger windows should be located on south east, south west or south facing elevations. The northern side of the building is more suitable for service and storage areas, with smaller windows to reduce heat loss.

In sustainability exemplars, to maximise the potential for passive solar gain, the arrangement of rooms and building form may need to shift away from the traditional arrangement.

Chapter 8 provides further information on these aspects.

7.4.2 Roofs

Roof pitch angles and arrangements:

- Roofs must be pitched at least 40° to the horizontal with the ridgeline generally running parallel to the principal elevation
- Gables should have a narrow form where visible from the public realm
- Hipped roofs are generally not acceptable
- In the case of very deep buildings where there is substantial usable accommodation within the roof space, the central part of the roof (at least 4.5m back from the gutters) may be virtually flat – with only enough slope to allow rainwater to drain
- Garages and other outbuildings should have pitched roofs wherever possible
- Projecting gables can be used occasionally. They must be narrow in profile

Roof materials:

- Roofs should be of clay tiles or grey roof slates. Thatch and stone slates are also locally characteristic
- Profiled concrete tiles are not acceptable
- Tile hanging and timber boarding is not appropriate on gables.
- Photovoltaic panels and tiles will be appropriate in many locations. See Chapter 8 for further information

Roof verge and eaves treatments:

- Roof verges should be kept very simple, with a mortared edge and no overhang. No fascias or bargeboards should be used
- Eaves should be 'clipped' i.e. simply pointed with mortar, with minimal or no overhang and no soffits or fascias. Gutters should be as tight as possible to the wall face
- Occasional copings / parapet walls can be found in the district
- Gutters and downpipes should be in painted metal (usually black)
- No upvc clip edges on verges or gables



Steeply pitched roof with no overhang, Bletchington



Inappropriate use of upvc clip edges, and fascias to gable



Guttering, South West Bicester

Chimneys and their locations:

- Chimneys are an important feature because they punctuate the skyline, articulate the roofline and therefore form an important component in the character of streets
- They should be of brick masonry construction and integral to the building (both in terms of construction and location)
- Working chimneys are preferred either providing a route for smoke or effluent from open fires or boilers or for mechanical ventilation, or acting as a termination of soil vent pipes
- They should be rectangular in form, located at the edge of the ridgeline and central to the gable
- They should project a minimum height of 1m above the ridgeline, with proportions relating to the overall scale of the host building and adjacent structures
- Windows or doors should not be located below a chimney
- Clay chimney posts should be used



Rectangular brick chimney at edge of ridgeline and central to gable, Bloxham



Rectangular brick chimney at edge of mid-terrace dwelling, central to gable, Adderbury

7.4.3 Doors and porches

Doors:

- All external doors should be in painted timber with a simple, well-proportioned design appropriate to the type and character of the property. For buildings of a formal character either four or six panelled design is appropriate, while timber ledge, braced or boarded designs are in keeping with a more informal, cottage style
- Large glass panels and mock fan-lights should be avoided
- Doors should be recessed into the wall by at least 50mm
- Door furniture should be simple, functional and in keeping with the character of the building
- Side lights to doors are discouraged



Flat porch, Adderbury

Porches:

- Porches should be in proportion with the building façade. Wide porches which cover an area larger than the front door itself will in most cases be unacceptable
- They should be open to the front and sides so that they are effectively just a canopy
- Simple porches should comprise a hood with a gabled or flat form projecting over the door, supported by timber brackets
- Larger porches should be supported by posts, but be in keeping with the size of building and context
- The height of porch roof eaves should line up with the top of the relevant door frame
- Blind walls to the street with entry to the side are not acceptable
- Pitched porch roof materials must match the main roof material
- No fibreglass, plastic or glass reinforced plastic to be used



Simple gabled porch, Chesterton



Unsuccessful example of plastic faux-tile porch, Banbury

7.4.4 Decoration

- Decoration is generally not acceptable on most buildings and is not characteristic of the simple vernacular architecture of the District
- Where decoration is used it must be traditionally detailed, functional and have a clear purpose
- Where decorative features are used on key buildings to emphasise their importance, these should take their design cues from the surrounding area

7.4.5 Services

- The visual impact of boxes, vents and flues should be considered at a layout stage to ensure these features do not negatively impact on the public realm
- Vents and flues should not be located on the front facade
- Electric and gas meters should, wherever possible, be located as close to the ground as possible on side or secondary elevations where they are not visible from the public realm. For terrace properties where this is not possible, boxes should be installed at a low level, preferably behind a wall or planting
- The choice of box colour should consider the walling material and location. If it is not possible to subtly match the colours, black should be the default



Subtle brick decoration



Simple hood mould decoration



Localised brick detail around doorways

8 INNOVATION AND SUSTAINABILITY



- 8.1 Sustainability and urban form**
- 8.2 Layout considerations**
- 8.3 Sustainable design and construction**
- 8.4 Sustainable technology**

CDC is a forward thinking Council which encourages innovations in design and construction to deliver higher levels of sustainability. The district has been leading the field in sustainability through the eco-town exemplar project at North West Bicester and is promoting the UK's largest self-build project at Graven Hill.

'Cherwell – safe, green, clean' is a priority of the Cherwell Business Plan 2017-18. There is a need to cut carbon, and since buildings make up 40% of carbon use, it is essential to use sustainable sources of energy and building technologies. New homes also need to be built to withstand less predictable and more extreme climatic conditions in the future. Other important considerations include water management, ecology, resource consumption and pollution, together with the wider social and economic aspects of sustainability.

Theme Three: Policies for Ensuring for Sustainable Development of the Cherwell Local Plan Part 1 2015 sets out the Council's strategy for ensuring that the impact of development on the District's environment is reduced, including taking steps to progressively reduce reliance on meeting energy needs from fossil fuels. Policies ESD 1 – ESD 17 deal with the Council's response to climate change including renewable energy and decentralised energy provision, sustainable construction, sustainable flood risk management and green infrastructure. Policy ESD 3: Sustainable Construction expects:

'All new residential development...to incorporate sustainable design and construction technology to achieve zero carbon development through a combination of fabric energy efficiency, carbon compliance and allowable solutions in line with Government policy.'

This chapter provides further information on these topics but does not set out specific guidelines as to how you develop homes with higher levels of sustainability; this is a rapidly changing field and the principles vary depending on the type of development. Rather, this chapter provides overarching principles and inspiration, setting out key issues which must be considered by all developments in the District. It forms a precursor to the planned Sustainable Buildings in Cherwell Supplementary Planning Document.

New development in Cherwell should:

- Consider sustainability objectives at the masterplan, plot and building scale
- Incorporate innovation in a manner which reinforces the principles of good urban design
- Create robust places which can adapt to future changes in the way we live and use technology
- Create healthy buildings which provide a safe and comfortable environment for their inhabitants

New development should avoid:

- Incorporating innovations without fully considering the wider impacts on masterplan layout and character of place
- Ostentatious architecture that does not sit comfortably with its context
- Weakening the fundamentals of good urban design for the sake of innovation

Please refer to the following chapter for supporting information:

- **Chapter 2:** For a summary of the District's distinctive characteristics and character areas
- **Chapter 3:** For details of how site analysis should be undertaken to inform the masterplan
- **Chapter 4:** For details of how a robust masterplan structure should be established
- **Chapter 5-6:** For the fundamental urban design principles for street and plot design.

Further reading:

- **The Environmental Design Pocketbook (2nd Edition), 2016, Sofie Pelsmakers**
- **The Sustainable Building Bible: An Insiders' Guide to eco-renovation & Newbuilding, 2011, Tim Pullen**
- **Climate Change and Adaption Report – NW Bicester, 2012, R Gupta, H Du and M Gregg (Oxford Brookes University)**
- **www.greenspec.co.uk** – independent online resource promoting sustainable building products, materials and construction techniques.
- **www.bre.co.uk** – for details of BREEAM assessment criteria and best practice examples

8.1 Sustainability and urban form

Consideration of sustainability is integral to good masterplanning and architectural design. The fundamental principles of sustainability should be embedded in all build programmes in the District.

To deliver Local Plan policy objectives, it is expected that sustainability will be considered at all stages of the design process from masterplanning to detailing. Sections 8.2 – 8.4 summarise the key issues to be considered.

The majority of development schemes will be expected to closely follow the guidance of chapters 4-7 reflecting the vernacular tradition of Cherwell. Sustainable building technologies should be incorporated in a sensitive manner without detriment to the architecture or street scene.

CDC actively promotes schemes which deliver exemplary levels of sustainability as at Bicester Eco-town. CDC recognises that innovative, non-traditional architecture and street typologies may be an appropriate design response in these circumstances.

Where innovation leads to deviation from chapters 4-7 of the Design Guide, CDC will agree bespoke design solutions with scheme promoters which are nonetheless compatible with the wider character of the district and are of an exceptional urban, landscape and architectural design standard. Additional time and investment will be required to develop the design in consultation with the Council.

Non-traditional architecture should have a sense of belonging to Cherwell and should draw on the key characteristics of traditional streets and buildings in the district, such as:

- the use of a simple palette of local building materials
- simple, non-fussy architecture and building typologies
- the arrangement of buildings in a terrace providing a strong frame to the street

Modern architecture does not have to be ostentatious. While it is appropriate for landmark buildings and others which make a significant contribution to the fabric of a place to stand out, the majority of buildings should be polite and sit comfortably together. In all schemes, the core principles of good urban design must still apply. For example, CDC will expect layouts to follow the principles of the perimeter block (see section 6.3) with buildings fronting onto streets and spaces and a clear definition of public/private boundaries, regardless of the architectural character or street orientation.

Sustainable exemplars therefore can be more expensive to deliver both in terms of time spent developing the design in consultation with the council and the use of high quality materials and detailing creating a more expensive build cost. However, there are many long term benefits from this approach including increased fuel efficiency, balancing these costs over the life-cycle of a building.



Zero carbon terrace, Upton, Northampton

8.2 Layout considerations

The masterplan layout has a fundamental impact on the sustainability of the scheme.

Site location

A sustainable approach to site allocation is embodied in the policies of the Local Plan and tested through the Sustainability Appraisal process.

Environmental and climate factors such as flood risk, and the potential impact of development on biodiversity and landscape assets are assessed together with social and economic sustainability considerations.

The location of development has a significant impact on how a place will function in the future and the impact of development on the environment.

- Locating development in proximity to existing community facilities, town centres and employment areas assists in reducing the need to travel by vehicle for day to day activities, as does the creation of new places with sufficient scale and diversity to generate the need for new local centres and services
- Tying into existing public transport routes, walking and cycling networks also supports a shift towards more sustainable modes of travel and reduced energy consumption



Multi-functional green corridor.

Masterplan

Chapter 4 explains how the structuring principles of the masterplan should be established, following robust urban design principles to deliver new places which have long lasting sustainability. These principles should be followed by all new developments.

Where the vision is for a sustainable exemplar with high levels of energy efficiency, it is recognised that this will have an influence on the urban form of the masterplan and the design of individual buildings.

The key considerations for sustainability include:

Land use mix

- Providing a mix of different sizes and tenures of homes, and non-residential uses within walking distance to encourage social interaction and community cohesion, and to reduce the need to travel for daily essentials (see section 4.3)
- Avoiding urban sprawl by making efficient use of the site. Higher density schemes generate demand for public transport and local facilities. Terrace homes and apartments are inherently more energy efficient than detached homes. (see section 4.8)
- Creating flexibility within the masterplan for uses to change and places to adapt over time
- Considering the potential to use modern methods of construction to reduce waste arising from construction and improve the energy performance of homes. Implications should be considered at the masterplan stage, for example: modular construction may limit the available building typologies and their arrangement
- Considering the incorporation of sustainable energy strategies such as Combined Heat and Power and ground source heat pumps and the implications these technologies have on density and land use mix

Movement

- Creating a connected, permeable street layout which encourages walking, cycling and the use of public transport rather than use of private cars (see section 4.4-4.5)
- Connecting new places into the existing movement network of the surrounding area (see section 4.6)
- Providing appropriate levels of cycle parking and safe and convenient cycling routes to encourage cycling for medium length journeys (see section 5.4)

- Incorporating infrastructure for electric vehicles. Every home should have access to at least one electric charging point and 20% of spaces in public car parks should have electric charging points (see section 5.8) unless a car free development is proposed
- Considering the potential for low car or car free developments and the impact of these on street typologies and car parking arrangements including the use of car clubs
- Considering the implications of emerging transport technologies such as autonomous vehicles on street design and the provision of car parking



Electric vehicle charging point.



Green roof

Green infrastructure

- Retaining and incorporating existing hedgerows, trees and other landscape features as part of a connected blue-green infrastructure network across the site (see section 4.7)
- Planning sustainable drainage features early-on, to allow sufficient space within the masterplan and considering the implications for street design and character. For example: street swales will increase the width of the street and may need to be balanced by taller building to create an appropriate sense of enclosure (see section 4.7)
- Using sustainable methods to manage landscape features for example: using greywater collection for irrigation and solar energy for irrigation pumps

Microclimate - wind

- Avoiding exposure to strong north or north westerly winds or the creation of wind tunnels by careful consideration of street alignment and avoiding localised strong winds created by individual buildings which are much taller than their neighbours
- Using existing landscape features such as tree belts and hedges or the planting of street trees, tree belts, shrubs and grassland to provide shelter from strong winds and to moderate extremes of temperature through evaporative cooling

Microclimate - sun

- Considering the impact of street orientation and street proportions on the natural day lighting/shading and temperature of buildings, gardens and public spaces. Streets with a 1:1.5 to 1:3 height to width ratio allow for good natural daylighting and pleasing proportions (see section 5.3)
- Planting deciduous tree species to offer shading to buildings and public spaces in summer and allow sunlight in during the winter
- Considering the impact of street and building orientation on the potential to harness solar energy using photovoltaic panels. Orientating roofs within 15-20 degrees of due south maximises the potential for light and solar gain (see section 4.9). In sustainable exemplars this may be a key driver for the masterplan street layout
- Considering future changes in temperature and the impact this will have on choice of planting and materials within the public realm

8.3 Sustainable design and construction

Policy ESD 2: Energy Hierarchy and Allowable Solutions of the Cherwell Local Plan Part 1, 2015 sets out an ‘energy hierarchy’ to achieve carbon emissions reductions. At the top of the hierarchy is the need to reduce energy use, in particular by the use of sustainable design and construction measures.

Building form

The building typology and layout of homes has a significant impact on their performance, for example:

- Apartment and terrace buildings have a greater thermal mass than detached buildings and have reduced external walls area to floor area, which help to moderate temperatures fluctuations and minimise heat loss
- All homes should be designed to allow natural cross ventilation and cooling in summer, for example: dual aspect apartments with opening windows on front and rear elevations; higher floor to ceiling heights and the use of high level vents to allow hot air to rise and be expelled and cool air to be drawn in at low level
- The arrangement of rooms and windows should consider the path of the sun and prevailing winds to reduce the need for artificial lighting, heating and cooling, for example by locating living rooms

and larger windows on the warmer southern aspects, and minimising windows on cooler/ exposed aspects

- Windows should be double or triple glazed and incorporate shutters or louvres to regulate solar gain and provide additional insulation
- Green roofs and walls should be incorporated where appropriate to provide insulation, water management and biodiversity benefits

Passivhaus

All schemes should consider the potential to deliver Passivhaus buildings. A Passivhaus is a super-insulated and airtight building, which does not need heating other than from solar gains, people using the building and appliances. It is fitted with a Mechanical Ventilation Heat Recovery unit (MVHR), which ensures there is always fresh air at room temperature. The MVHR can be fitted with an electric heater for top-up heat. Passivhaus use only 10% of the heating energy compared to conventional new builds. Windows can be opened and the buildings are known for high room comfort and good air quality.

Further information on Passivhaus specification and certification is available from the Passivhaus Trust at <http://www.passivhaustrust.org.uk/>.



Larch House, Ebbw Vale is the UK's first zero carbon (code 6), low cost, Certified Passivhaus.

Building fabric

The concept of embodied energy (or more specifically embodied carbon) considers the greenhouse gas emissions which are created during the life cycle of a material for example during extraction, manufacturing, transportation, installation and demolition.

In choosing building materials, embodied carbon should be considered (together with pollution impacts) alongside the carbon savings arising from the performance of the material in the home.

Considerations include:

- Re-using and refurbishing existing buildings, rather than demolition and new build
- The use of recycled and reused materials including locally reclaimed bricks, reclaimed roof slates and tiles, and recycling or reusing waste products arising from demolition and construction on site
- The use of locally sourced materials to reduce the energy expended in transporting materials, to support the local economy and to maintain the traditions of building in Cherwell (see section 7.3 for guidance on appropriate local materials)
- The use of cement substitutes in the manufacture of concrete blocks such as ground granulated blast furnace slag (GGBS) and recycled aggregate (RA) and recycled concrete aggregates (RCA) to replace quarried aggregate, or alternatives to concrete such as Ziegler clay blockwork to reduce embodied carbon
- The use of Modern Methods of Construction (MMCR) where elements (panels or 3D volumes) of the building fabric are manufactured off site in controlled factory conditions. The potential benefits include increased build efficiency, high energy performance products and quality assurance, reduced construction waste, construction time and impacts on site. MMCR covers a range of construction types including timber frame and Structural Insulated Panels (SIPS) which are lightweight but deliver high thermal performance
- Ensuring all timber used is from PEFC or FSC certified sources, ensuring responsible management of the world's forests



Modular construction factory, Ashford
(image courtesy of Brooke Homes)



Murray Street, London (source: Andrew Farrar, AJ Buildings Library)

8.4 Sustainable technology

The use of digital apps allowing users to control home heating while out of the home, and smart energy and water meters gives householders greater understanding and control over their daily energy and water consumption.

This smarter use of resources should be combined with the provision of energy in efficient and renewable forms, to deliver comfortable, low cost living environments.

CDC's energy hierarchy promotes the following strategies in the order listed below:

- Supplying energy efficiently and giving priority to decentralised energy supply
- Making use of renewable energy
- Making use of allowable solutions (further details of this are to be set out in the Sustainable Buildings in Cherwell SPD and Local Plan Part 2)

Decentralised energy

Local Plan Policy ESD 4 provides details of the use of decentralised energy systems either District Heating (DH) or combined heat and power (CHP) systems, to increase the efficiency of energy distribution. Scheme promoters should refer to The Renewable Energy and

Local Carbon Map, Local Plan Part 1 Appendix 5 for locations with potential for decentralised heat supply in the district.

Combined Heat and Power (CHP)

CHP systems utilise the waste heat produced when fuel is burnt to generate electricity, to heat homes and water. In conventional power generation large quantities of energy in the form of heat are wasted. By using this technique, the total energy conversion efficiency can reach 90%.

CHP can use renewable fuel sources such as biomass (energy crop or organic waste product) or be gas-fired (non-renewable).

Traditionally CHP has been used at the district or community scale, and most effective in relatively dense, mixed use developments. Micro-CHP serving individual homes is now becoming a commercially viable alternative to the traditional gas central heating boiler, while also providing electricity.

In the longer term fuel cell technology which generates electricity and heat directly through the combining of hydrogen and oxygen, could be used for micro-CHP.



Solar energy capture on homes of traditional and modern design, Villers Road, London (source: Architects Journal)

Renewable energy sources

Alongside biomass CHP, solar, wind and ground source heat pumps should be considered as potential sources of renewable energy.

Solar

Solar energy is captured using PV cells or solar water heating panels and require a south facing, unshaded roof.

- Photovoltaic (PV) cells use light to generate electricity and often directly feed electricity into the building. With the latest PV technology, cells can also be integrated into the roof tiles themselves, minimising visual impact. The cells can be grid connected, off-grid or hybrid and groups of solar PV cells can be added together to provide increasing levels of power
- Solar water heating panels uses the radiation from the sun to heat water which can supply that heat either as hot water or into a central heating system. If the system has been sized correctly, it can provide at least 40-60% of all household hot water requirements throughout the year. Unfortunately the demands on the central heating system are at their highest when the sun is weakest so a solar heating system will only contribute to part of a household's heating energy requirements

Wind

Wind turbines may be appropriate to generate electricity for individual or small numbers of dwellings in rural areas, subject to appropriate siting of the turbine away from dwellings and careful consideration of wider visual impact. In urban areas, they are unlikely to offer a viable form of energy generation.

Ground and Air source heat pumps

Ground source heat pumps utilise the constant below ground temperate and transfer heat from below the frost line into the building. They are effective in combination with low energy heating systems such as underfloor heating.

Air source heat pumps use the same principle but extract the heat from the air, rather than the ground. Their installation is much simpler and cheaper but the available heat is not constant and limited in winter months.

These systems require electricity to drive them, but in an efficient system where the heat gained is significant, one kilowatt of energy can generate three kilowatts of heat. The pumps have fewer mechanical parts than conventional heating systems, making them durable and more reliable. They also do not require external venting as fossil fuel systems do, so they do not pollute the air.

Water management

Use of water in the home from the mains should be minimised in all developments utilising approaches including:

- The fitting of low flow water goods
- Retention of roof water, for example through green roof systems and water butts
- Rainwater harvesting from roofs and grey water recycling which can be used for irrigation and toilet flushing, amongst other things
- Recycling of grey water through dual plumbing systems
- Recycling of black water is also an option through biological solutions



Street and roof orientation optimised for PV effectiveness, NW Bicester.

APPENDICES



Appendix A: Reading list

Appendix B: Local Plan Part 1, Policy ESD 15

Appendix C: List of Conservation Areas (2017)

Appendix D: Countryside Character Areas, settlement classification

Appendix E: Net density calculation

Appendix F: Residential Road Design Guide, OCC, Appendix A6

Parking standards for the City & Districts

Appendix G: Cherwell Design Initiative

Appendix A: Reading List

Building Research Establishment, www.bre.co.uk

Berks, Bucks and Oxon Wildlife Trust, <http://www.bbowt.org.uk/>

British Geological Survey, <http://www.bgs.ac.uk/>

BS 5837:2012, Trees in relation to design, demolition and construction, 2012, BSI

BS 5906:2005, Waste management in buildings. Code of practice, 2005, BSI

Building for Life 12, Design for Homes, 2012, Design Council

Car Parking, What Works Where, 2006, English Partnerships

Cherwell District Council Strategic Flood Risk Assessment, 2009, Cherwell District Council, <http://www.cherwell.gov.uk/index.cfm?articleid=4356>

Cherwell District Local Plan 2011-2031 Part 1, 2015, Cherwell District Council

Climate Change and Adaption Report – NW Bicester, 2012, R Gupta, H Du and M Gregg (Oxford Brookes University)

Countryside Design Summary, 1998, Cherwell District Council

Colour Palettes: Banbury, Bicester, Kidlington, 1996, Roger Evans Associates for CDC

Creating Successful Masterplans, 2004, CABE

Environment Agency, <https://www.gov.uk/government/organisations/environment-agency>

Essex Design Guide, 2005, Essex County Council

Greenspec, www.greenspec.co.uk

Historic Environment Record <https://www.oxfordshire.gov.uk/cms/content/historic-environment-record>, Oxfordshire County Council

Listed Buildings Register <https://www.historicengland.org.uk/listing/the-list>, Historic England

MAGIC www.magic.gov.uk

Manual for Streets, 2007, DfT/DCLG

Manual for Streets 2, 2010, DfT

National Planning Policy Framework, 2012, DCLG

Natural England, <https://www.gov.uk/government/organisations/natural-england>

Office for National Statistics, <https://www.ons.gov.uk/>

Oxfordshire Wildlife and Landscape Study (OWLS), <http://owls.oxfordshire.gov.uk/wps/wcm/connect/occ/OWLS/Home>

Parking: Demand and Provision in Private Sector Housing Developments, 1996, J Noble and M Jenks

Planning Policy Statement 3: Housing, 2010, CLG <http://webarchive.nationalarchives.gov.uk/+http://www.communities.gov.uk/planningandbuilding/planning/planningpolicyguidance/planningpolicystatements/planningpolicystatements/pp3/>

- Responsive Environments, A Manual For Designers**, 1985, Bentley, Alcock, Murrain, McGlynn, Smith
- Residential Road Design Guide**, 2nd Edition 2015, Oxfordshire County Council
- Sewers for Adoption**, 7th edition 2012, WRc plc
- Site layout planning for Daylight and Sunlight: a guide to good practice**, 2011, BRE
- Susdrain**, <http://www.susdrain.org/> CIRIA
- Sustainable Design and Construction SPD**, 2016, Barnet Borough Council
- The Environmental Design Pocketbook (2nd Edition)**, Sofie Pelsmakers, 2016
- The Residential Car Parking Research**, 2007, DCLG
- The SuDS Manual (C753)**, 2015, CIRIA, www.susdrain.org
- The Sustainable Building Bible: An Insiders' Guide to eco-renovation & Newbuilding**, Tim Pullen, 2011
- Traditional Dormer Windows - Design Guide**, 2003, Cotswold District Council
- Trees in Hard Landscapes: A Guide for Delivery**, 2014, Trees & Design Action Group
- Urban Design Compendium**, 2nd Edition 2007, English Partnerships
- Urban Design Compendium 2**, 2007, English Partnerships
- West Oxfordshire Design Guide**, 2016, West Oxfordshire District Council
- Written Statement to Parliament - Sustainable Drainage Systems**, 2014, DCLG <https://www.gov.uk/government/speeches/sustainable-drainage-systems>

Appendix B: Local Plan Part 1, Policy ESD 15

Successful design is founded upon an understanding and respect for an area's unique built, natural and cultural context. New development will be expected to complement and enhance the character of its context through sensitive siting, layout and high quality design. All new development will be required to meet high design standards. Where development is in the vicinity of any of the District's distinctive natural or historic assets, delivering high quality design that complements the asset will be essential.

New development proposals should:

- Be designed to deliver high quality safe, attractive, durable and healthy places to live and work in. Development of all scales should be designed to improve the quality and appearance of an area and the way it functions
- Deliver buildings, places and spaces that can adapt to changing social, technological, economic and environmental conditions
- Support the efficient use of land and infrastructure, through appropriate land uses, mix and density/development intensity
- Contribute positively to an area's character and identity by creating or reinforcing local distinctiveness and respecting local topography and landscape features, including skylines, valley floors, significant trees, historic boundaries, landmarks, features or views, in particular within designated landscapes, within the Cherwell Valley and within conservation areas and their setting. Conserve, sustain and enhance designated and non designated 'heritage assets' (as defined in the NPPF) including buildings, features, archaeology, conservation areas and their settings, and ensure new development is sensitively sited and integrated in accordance with advice in the NPPF and NPPG. Proposals for development that affect non-designated heritage assets will be considered taking account of the scale of any harm or loss and the significance of the heritage asset as set out in the NPPF and NPPG. Regeneration proposals that make sensitive use of heritage assets, particularly where these bring redundant or under used buildings or areas, especially any on English Heritage's At Risk Register, into appropriate use will be encouraged (see chapter 3/ Conservation Area Appraisals)
- Include information on heritage assets sufficient to assess the potential impact of the proposal on their significance. Where archaeological potential is identified this should include an appropriate desk based assessment and, where necessary, a field evaluation (see chapter 3/ Conservation Area Appraisals)
- Respect the traditional pattern of routes, spaces, blocks, plots, enclosures and the form, scale and massing of buildings. Development should be designed to integrate with existing streets and public spaces, and buildings configured to create clearly defined active public frontages
- Reflect or, in a contemporary design response, re-interpret local distinctiveness, including elements of construction, elevational detailing, windows and doors, building and surfacing materials, mass, scale and colour palette
- Promote permeable, accessible and easily understandable places by creating spaces that connect with each other, are easy to move through and have recognisable landmark features
- Demonstrate a holistic approach to the design of the public realm to create high quality and multi-functional streets and places that promotes pedestrian movement and integrates different modes of transport, parking and servicing. The principles set out in The Manual for Streets should be followed
- Consider the amenity of both existing and future development, including matters of privacy, outlook, natural lighting, ventilation, and indoor and outdoor space Limit the impact of light pollution from artificial light on local amenity, intrinsically dark landscapes and nature conservation
- Be compatible with up to date urban design principles, including Building for Life, and achieve Secured by Design accreditation
- Consider sustainable design and layout at the masterplanning stage of design, where building orientation and the impact of microclimate can be considered within the layout
- Incorporate energy efficient design and sustainable construction techniques, whilst ensuring that the aesthetic implications of green technology are appropriate to the context

- Integrate and enhance green infrastructure and incorporate biodiversity enhancement features where possible (see Policy ESD 10: Protection and Enhancement of Biodiversity and the Natural Environment and Policy ESD 17 Green Infrastructure). Well designed landscape schemes should be an integral part of development proposals to support improvements to biodiversity, the micro climate, and air pollution and provide attractive places that improve people's health and sense of vitality
- Use locally sourced sustainable materials where possible.
- The Council will provide more detailed design and historic environment policies in the Local Plan Part 2.
- The design of all new development will need to be informed by an analysis of the context, together with an explanation and justification of the principles that have informed the design rationale. This should be demonstrated in the Design and Access Statement that accompanies the planning application. The Council expects all the issues within this policy to be positively addressed through the explanation and justification in the Design & Access Statement. Further guidance can be found on the Council's website.

Appendix C: List of Conservation Areas (2017)

Adderbury	Rousham (includes Lower and Upper Heyford)
Ardley	Shenington with Alkerton
Balscote	Sibford Ferris
Banbury	Sibford Gower and Burdrop
Banbury Grimsbury	Somerton
Barford St John	Souldern
Barford St Michael	South Newington
Begbroke	Steeple Aston
Bicester	Stratton Audley
Bletchinghamdon	Swalcliffe
Bloxham	Tadmarton
Bodicote	Wardington
Charlon-on-Otmoor	Weston on the Green
Chesterton	Wigginton
Cottisford	Williamscot
Cropredy	Wroxton
Deddington	
Drayton	
Duns Tew	
Fewcott	
Fritwell	
Hampton Gay, Shipton on Cherwell & Thrupp	
Hampton Poyle	
Hanwell	
Hethe	
Hook Norton	
Horley	
Hornton	
Islip	
Juniper Hill	
Kidlington: Church Street, High Street, The Rookery, Crown Road, Langford Lane Wharf	
Kirtlington	
Milton	
Mixbury	
Mollington	
North Aston	
North Newington	
Oxford Canal	
RAF Bicester	
RAF Upper Heyford	

Appendix D: Countryside Character Areas, settlement classification

Cherwell Valley

Claydon, Clifton, Cropredy, Great Bourton, Little Bourton, Lower Heyford, Middle Aston, Nethercote, North Aston, Northbrook, Somerton, Steeple Aston, Upper Heyford, Wardington, Willamscot.

Ironstone Downs

Adderbury, Alkerton, Balscote, Barford St John, Barford St Michael, Bloxham, Bodicote, Broughton, Burdrop, Deddington, Drayton, Duns Tew, Epwell, Hanwell, Hook Norton, Horley, Hornton, Lower Tadmarton, Milcombe, Milton, Mollington, North Newington, Shenington, Shutford, Sibford Ferris, Sibford Gower, South Newington, Swalcliffe, Upper Tadmarton, Wigginton, Wroxton.#

Ploughley Limestone Plateau

Ardley, Bainton, Bletchingdon, Bucknell, Caulcott, Caversfield, Chesterton, Cottisford, Fewcott, Finmere, Fringford, Fritwell, Godington, Hardwick, Hethe, Juniper Hill, Kirtlington, Little Chesterton, Middleton Stoney, Mixbury, Newton Purcell, Souldern, Stoke Lyne, Stratton Audley.

Clay Vale of Otmoor

Ambrosden, Arncott, Begbroke, Blackthorn, Bunkers Hill, Charlton-on-Otmoor, Enslow, Fencott, Gosford, Hampton Gay, Hampton Poyle, Horton-cum-Studley, Islip, Launton, Merton, Murcott, Noke, Oddington, Piddington, Shipton-on-Cherwell, Thrupp, Wendlebury, Weston-on-the-Green, Yarnton.

Appendix E: Net density calculation

Net density is calculated by including only those site areas which will be developed for housing and directly associated uses.

This would normally include the following uses:

- Access roads within the site
- Private garden space
- Car parking areas
- Incidental open space and landscape
- Children's play areas (where these are to be provided)

Net density normally excludes:

- Major distributor roads
- Primary schools
- Open spaces serving a wider area
- Significant landscape buffer strips

Appendix F: Residential Road Design Guide, OCC, Appendix A6 Parking standards for the City & Districts

A6.B – Cherwell Urban Areas Parking Standards

The parishes, which define the urban areas in Cherwell are:

- i. Banbury,
- ii. Bicester,
- iii. Kidlington,
- iv. Bloxham,
- v. Bodicote,
- vi. Adderbury,
- vii. Yarnton
- viii. Gosford & Water Eaton.

The car parking provision in new developments for the urban areas in Cherwell area are set out in Table A6.B1.

Number of bedrooms per dwelling	Number of allocated spaces	Number of spaces when 2 allocated spaces per dwelling are provided		Number of spaces when 1 allocated spaces per dwelling are provided		Number of unallocated spaces when no allocated spaces are provided
		Allocated spaces	Unallocated spaces	Allocated spaces	Unallocated spaces	
1	1	N/A	N/A	1	0.4	1.2
2	2	2	0.3	1	0.6	1.4
2/3	2	2	0.3	1	0.7	1.5
3	2	2	0.3	1	0.8	1.7
3/4	2	2	0.4	1	1.0	1.9
4+	2	2	0.5	1	1.3	2.2

Note 1: The rows in the table for 2/3 bedrooms and 3/4 bedrooms can be used when there are additional rooms in the dwelling which are not shown as bedrooms but where there is a high chance that they could be used as bedrooms.

Note 2: The Council will consider North West Bicester Ecotown as a special case provided that certain minimum criteria are met. If there is a full range of every day services provided within easy walking or cycling distance of the dwelling and convenient access to an efficient public transport system accessing a wider range of services including employment, one allocated car parking space per dwelling will be required, regardless of dwelling size or tenure. This may be on plot or off plot. Off plot provision may be grouped in a parking court provided the courts are small, close by, secure and conveniently accessed. Additional unallocated off plot car parking may also be provided according to the principles of this document up to a maximum of one space per dwelling. A lower standard of parking may be acceptable dependent upon the layout and accessibility to services and to other modes of transport in agreement with the Highway Authority.

A6.C – Parking Recommendations for all Other Areas in Oxfordshire (Other than Oxford and Cherwell Urban Areas)

Car parking provision recommendations for all other areas of Oxfordshire (other than Oxford and Cherwell Urban Areas) are set out in Table A6.C1.

Table A6.C1 Car parking Provision in New Developments for all Areas of Oxfordshire (Other than Oxford and Cherwell Urban areas)						
Number of bedrooms per dwelling	Number of allocated spaces	Number of spaces when 2 allocated spaces per dwelling are provided		Number of spaces when 1 allocated spaces per dwelling are provided		Number of unallocated spaces when no allocated spaces are provided
		Allocated spaces	Unallocated spaces	Allocated spaces	Unallocated spaces	
1	1	N/A	N/A	1	0.4	1.2
2	2	2	0.3	1	0.6	1.4
2/3	2	2	0.3	1	0.8	1.6
3	2	2	0.4	1	0.9	1.8
3/4	2	2	0.5	1	1.1	2.1
4+	2	2	0.6	1	1.5	2.4

Note: The rows in the table for 2/3 bedrooms and 3/4 bedrooms can be used when there are additional rooms in the dwelling which are not shown as bedrooms but where there is a high chance that they could be used as bedrooms.

Appendix G: Cherwell Design Initiative

The Design Guide is an important document in establishing a positive design agenda across the District. It cannot in isolation secure high quality design across the district, but needs to work in combination with other programmes if good quality design is to be secured. This includes:

- i. Design Training
- ii. Development Audit
- iii. Use of Design Review Panels
- iv. Use of Design Coding
- v. Use of Developers Briefs

i. Design Training of Planners and Elected Members

Equipping planners and members of the planning committee with the skills to confidently comment and negotiate on planning applications in the planning process is critical to the success of the Guide. Regular training will be provided to planners and elected members on key issues to ensure the optimal use of the Design Guide.

ii. Development Audit

The Guide has been written to promote high quality design principles, but also to reflect the development challenges that CDC face as a Local Planning Authority. A development audit will take place every two years to review the quality of development and consider whether changes to the Guide are required.

iii. Design Review

The use of Design Review Panels provides a forum where the design principles, masterplans and design details can be tested with a range of independent experts. Design review can help to achieve high standards, by testing the design principles that are embedded within the scheme, to ensure that these are fit for purpose and that the development is in the right place and responds well to its surroundings. Design review is referred to in paragraph 62 of the National Planning Policy Framework. This says that local authorities should have local design review arrangements and that they should give weight to the findings of design review panels.

Design review:

- Makes it easier to resolve design issues in the planning process
- Can help to improve the design of a project; identifying ways to make it function better and be more user-friendly
- Helps to achieve consensus around design objectives, and offers ways of engaging with interested parties e.g. highways officers, politicians and communities
- Offers a fresh perspective, providing solutions to seemingly intractable design issues
- Can help to address the viability question. In some cases projects can be simplified through more efficient design solutions or improved design can unlock higher sale or rental values

At CDC we have promoted the use of design review Panels on many schemes and the feedback has been positively received by developers, members and planners. One of its main benefits is its independence, supporting a dialogue which is isolated from the on-going negotiation between Officers and Developers. It helps all parties stand back from the development process to take stock. It has been a useful tool to help applicants and planners to promote good design and identify poor design.

There are three design panels that we use:

- BOB MK: small scale local residential schemes
- Design South East: strategic local plan schemes
- CABE: regionally important sites, such as exemplar and town centre regeneration schemes

We are currently investigating the option for a Bicester Design Panel, which will provide specific guidance relevant to the Bicester Garden Town Agenda.

In all cases, panel members are drawn from a variety of fields, including urban designers, town planners, architects, landscape architects, developers, engineers and chaired by an experienced practitioner who ensures that the review remains focused at all times and that everyone is given the appropriate opportunity to participate.

Timing

The point in the design process when design review should be undertaken will vary according to the scale and nature of the project. For the majority of developments this will be part way through the design process, when the strategic design approach has been established, but before the detail has been fully resolved.

This approach provides time for the review to become a constructive part of the design process and allow for any issues raised by the panel to be thoughtfully integrated before a formal planning application is submitted. With the smaller scale projects such as the public buildings and private houses it might be more appropriate to use design review at the later stages of the design process.

Strategic projects - Outline:

- Design workshop as part of pre-app process
- Design review of application when it is validated
- Design review of final scheme, where significant changes were required to proposals

Strategic projects – Full / Reserve Matters:

- Design workshop as part of pre-app process
- Design review of application when it is validated
- Design review of final scheme, where significant changes were required to proposals

Major Sites:

- Design review when application is validated

Other Sites:

- Rural exception sites
- On a case-by case basis

iv. Design Codes

The objective of design codes is to provide a clear framework for development that is supported by all parties. This is particularly important on sites with multiple land holdings or where the site is likely to be constructed by several developers / house builders over the life of the scheme.

Design codes are particularly relevant to strategic development sites (over 300 units) where the requirement for design codes is conditioned in the approval of the Outline Application. For sites identified in the Cherwell Local Plan, this requirement is set out within site specific policies in the Cherwell Local Plan.

The Council see design codes as being important to:

- Establish a long term vision and design led framework for the site
- Build upon the work established by the outline planning application and the design and access statement for the area
- Ensure overall coordination and consistency between development sites
- Provide a level of certainty to the Landowner, Council, Developer and the community
- Provide a clear guide for developers working on individual plots and sets the context for more detailed design work.

It will be important that the codes establish the design principles in five areas:

- Vision and development framework
- Streets / movement network
- Public realm
- Urban form and morphology
- Materials and details.

Establishing the level of prescription for the codes will be important and clear performance criteria should be established for each development area, setting out the level of prescription alongside desired and mandatory requirements.

Design codes need to convey a lot of information and can often be complicated and difficult to understand to a third party. It is important that the format of the codes is clearly thought through at an initial stage and that early pages set out how the codes should be used / navigated. Good design codes make extensive use of plans, sections and 3D illustrations to set out the objectives for each area. Simple illustrations can often explain much more than words and photos.

Stages of design code production:

1) Establishing a Vision and Development Framework

The first stage should build upon the work already undertaken for the site such as the Illustrative Masterplan and Design and Access Statement. Many of the key principles such as the movement network, building heights and density will have already been set out by the Design and Access Statement for the site.

The key aspects to focus on at this stage are:

- Define the character areas
- Define special conditions within character areas
- Define what the features / areas are that provide continuity through the site (e.g. Streets / public realm / landscape)
- Define the character cues which will differentiate the character areas. These should build upon the character of the existing site and it is anticipated that the cues will generally reflect the 20th and 21st century rather than traditional villages.

2) Streets / Movement Network

Streets and public realm form will be important in establishing a broad character for the site. Streets and open spaces will cross different character areas and will be important in providing continuity across the site. Streets should be designed as key aspects of the public space. The nature and form of the streets will vary according to their connectivity. The design of open spaces will vary depending on their location on site and their function.

The key aspects are likely to be:

- Scale and setting of the street
- The movement network should be designed to be pedestrian and cyclist friendly to maximise sustainable forms of transport. This relates both to the overall street hierarchy down to design and detail
- Parking should be carefully considered and is likely to vary depending upon the site location, density and housing typology
- SUDS and drainage
- Materials and details (with emphasis on materials which support a public realm approach)

3) Public Realm

The character of the public realm form will help to establish a broad character for the site that crosses different character areas. The design of open spaces will vary depending on their location on site and their function.

The key aspects are likely to be:

- Scale and character of open space. Some spaces, especially near the school and local centre are likely to be formal in character while other spaces, such as areas dominated by SUDS and ecological features are likely to have a less formal character
- Landscape and planting
- Front threshold detail
- Private gardens.

4) Urban form and morphology

The way that buildings relate to one another is one of the most important aspects that can be used to define an areas character. The proportion, massing, shape and layout of buildings will be important elements of character. Other cues such as defining building lines, eaves heights, ridge heights, alongside the rhythm / spacing between buildings will be important in establishing formal or informal character cues.

The key aspects are likely to be:

- Urban form (relationship of buildings to one another)
- Building typology (terrace, detached etc.)
- Density
- Building lines (consistent or varied)
- Height / enclosure
- Roofscape (Roof form, consistent or varied eaves / ridge heights)
- Scale and proportion and the buildings and its fenestration (important for both urban form and detail).

5) Building Material and Detail

The materials and details are likely to vary in different areas of the site. We would expect a simple palette of materials to be established that will vary according to the character area and condition. The Council would support innovative construction approaches that further a sustainable approach to the development.

- Building detail (window arrangement and proportions, balconies etc)
- Building materials (for roof and main building fabric. This can also include materials that will not be acceptable)
- Scale and proportion and the buildings and its fenestration (important for both urban form and detail).

v. Planning Briefs

Planning briefs aim to assist in the redevelopment of sites by acting as a 'stepping stone' between the matters that will need to be addressed in any application for planning permission and the local policies contained in the Cherwell Local Plan. These documents are used to set out the council's vision and requirements for the development of a site /collection of sites. Planning briefs vary according to factors such as: the nature of the site; the location; the ownership of the site; and the political context.

A planning brief is generally produced for strategic, complicated and sensitive sites which require more detailed planning guidance. It is anticipated that these documents will provide consistent, quality guidance to developers, and thus improve the planning process and the quality of the final development.

Planning briefs are used in Cherwell to:

- Provide site specific guidance for the development of strategically important sites
- Set out the vision for development of an area
- Improving the quality of development.
- Improve the efficiency of the planning and development process; and
- Help promote the development of a difficult site, with complicated constraints and / or land ownership patterns

A planning brief provides more detail of development options and issues than Local Plan Policies, but does not alter policies in the local plan. A good planning brief should help to provide clarity in the development process; making it clear what is likely to be acceptable and what is unacceptable; where there is flexibility and where requirements are firm.

At Cherwell, planning briefs typically contain information on:

Site constraints

- Heritage and archaeology
- Hydrology and flooding
- Existing movement network
- Land ownership
- Landscape
- Services

Context

- Urban form and character
- Landscape structure
- Streetscape and public realm

Urban Design Issues

- Framework plan
- Uses
- Heights and massing
- Landmark features
- Public realm

